

User's Guide

EH-LS10500

Home Projector



Using Each Guide

The guides for this projector are organized as shown below.

Safety Instructions/Support and Service Guide

Contains information on using the projector safely, as well as a support and service guide, troubleshooting check lists, and so on. Make sure you read this guide before using the projector.



User's Guide (this guide)

Contains information on setting up and basic operations before using the projector, using the Configuration menu, and handling problems and performing routine maintenance.



Quick Start Guide

Contains information on the procedures for setting up the projector. Read this first.



3D Glasses User's Guide

Contains information on handling the 3D Glasses and warnings and so on.

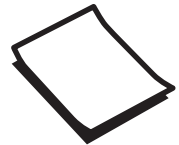



Notations Used in This Guide

Safety Indications

The User's Guide and the projector use graphical symbols to show how to use the projector safely. The following shows the symbols and their meanings. Please understand and respect these caution symbols in order to avoid injury to persons or property.

 **Warning**

This symbol indicates information that, if ignored, could possibly result in personal injury or even death due to incorrect handling.



 **Caution**

This symbol indicates information that, if ignored, could possibly result in personal injury or physical damage due to incorrect handling.

General Information Indications

Attention

Indicates procedures which may result in damage or malfunctions to occur.

	Indicates additional information and points which may be useful to know regarding a topic.
	Indicates a page where detailed information regarding a topic can be found.
Menu Name	Indicates Configuration menu items. Example: Image - Color Mode
Button Name	Indicates the buttons on the remote control or the control panel. Example:  button

About the Use of "This Product" or "This Projector"

As well as the main projector unit, supplied items or optional extras may be referred to using the phrase "this product" or "this projector".

Organization of the Guide and Notations in the Guide

Using Each Guide	1
Notations Used in This Guide	2
Safety Indications	2
General Information Indications	2
About the Use of "This Product" or "This Projector"	2

Preparing

Part Names and Functions 6

Front/Top	6
Rear	7
Interface	8
Base	9
Control Panel	10
Remote Control	11

Installing 15

Notes on Installing	15
How to Install	16
Placing on a shelf and projecting	16
Suspending from the ceiling and projecting	16
Projection Distance and Lens Shift Maximum Values	17

Connecting a Device 20

Removing the Cable Cover	20
Connecting Video Devices	20
Equipment with HDMI output ports	21
Equipment with a video output port	21
Equipment with component video output ports	21
Connecting a Computer	21
Computers with an RGB output port	22
Computers with an HDMI output port	22
Connecting External Devices	22
Connecting to Trigger out 1/Trigger out 2 ports	22
Connecting to the LAN port	23
Securing Cables with the Cable Clamp	23

Preparing the Remote Control 24

Installing Batteries	24
Remote Control Operating Range	24
Operating range (left to right)	24
Operating range (top to bottom)	24

Basic Operations

Turning the Projector On and Off 25

Turning On	25
Turning Off	26

Configuration Menu Operations 27

Adjusting the Projected Screen 29

Displaying the Test Pattern	29
Adjusting the Projector's Tilt	29
Lens Adjustment Function (Focus, Zoom, Lens Shift)	29
Adjusting the focus	30
Adjusting the projection size (zoom adjustment)	30
Adjusting the position of the projected image (lens shift)	31
Keystone	31
Switching the Source	32
Aspect	32
Hiding the Image Temporarily	34

Viewing 3D Images 35

Warnings Regarding Viewing 3D Images	35
Projecting 3D Images	37
When the projector detects a 3D format	37
When the projector cannot detect a 3D format	37
If the 3D image cannot be viewed	38
Preparing the 3D Glasses	38
Charging the 3D Glasses	38
Pairing 3D Glasses	39
Wearing and viewing with the 3D Glasses	39
Range for Viewing 3D Images	39
Converting 2D Images to 3D Images and Viewing	40

Setting Image Quality

Basic	42
Color Mode	42
Super-resolution/4K Enhancement	43
Detail Enhancement	45
Dynamic Contrast	45
Frame Interpolation	46
Precise Image Adjustment	47
Hue, Saturation, and Brightness	47
Gamma	47
Select and adjust the correction value	48
Adjust while viewing the image	48
Adjust using the gamma adjustment graph	48
RGB (Offset/Gain)	49
Color Temp.	49
Skin Tone	50
Sharpness	50
Lens Iris	51
Panel Alignment	51
Image Processing	52

Useful Functions

HDMI Link	54
HDMI Link Function	54
HDMI Link Settings	54
Selecting the Connected Device	55
Lens Position Function	56
Saving the Lens Position	56
Loading the Lens Position	56
Erasing the Lens Position	57
Renaming the Lens Position	57
Memory Function	58
Settings that can be Saved	58
Saving the Memory	58
Loading the Memory	59
Erasing the Saved Memory	59
Renaming the Memory	59
Picture in Picture	61

Types of Screen that can be Displayed Simultaneously	61
Starting and Exiting Picture in Picture	61
Picture in Picture Settings	62

Operations and Settings Using the Network

Making Settings and Performing Operations from a Web Browser	63
Changing the projector's settings (Web Control)	63
Operating the projector (Web Remote)	64
Using the Mail Notification Function to Report Problems	66
Reading error notification mail	66

Configuration Menu

Configuration Menu Functions	68
Configuration Menu Table	68
Image menu	68
Signal menu	70
Settings menu	73
Memory menu	77
Network menu	77
Info menu	81
Reset menu	82
Picture in Picture menu	82

Troubleshooting

Problem Solving	83
Reading the Indicators	83
Indicator status during an error/warning	83
Indicator status during normal operation	84
When the Indicators Provide No Help	85
Check the problem	85
Problems relating to images	86
Problems when projection starts	91
Problems with the remote control	91
Problems with the control panel	91
Problems with 3D images	92
Problems with HDMI	92

Maintenance

Maintenance	94
Cleaning the Parts	94
Cleaning and replacing the air filter	94
Cleaning the main unit	95
Cleaning the 3D Glasses	96

Appendix

Optional Accessories and Consumables	97
Optional Items	97
Consumables	97
Supported Resolutions	98
HDMI1/HDMI2 Input Signals	98
Component Video	98
Composite Video	98
Computer Signals (Analog RGB)	98
3D Input Signals	99
Notes on Transportation	100
Moving Nearby	100
When Transporting	100
Preparing packaging	100
Notes when packing and transporting	100
Specifications	101
Appearance	106
Glossary	107
General Notes	108
Warnings and Cautions Regarding the Laser	109
Laser optical path	111
List of Safety Symbols	113
General Notice	115



Part Names and Functions

Front/Top

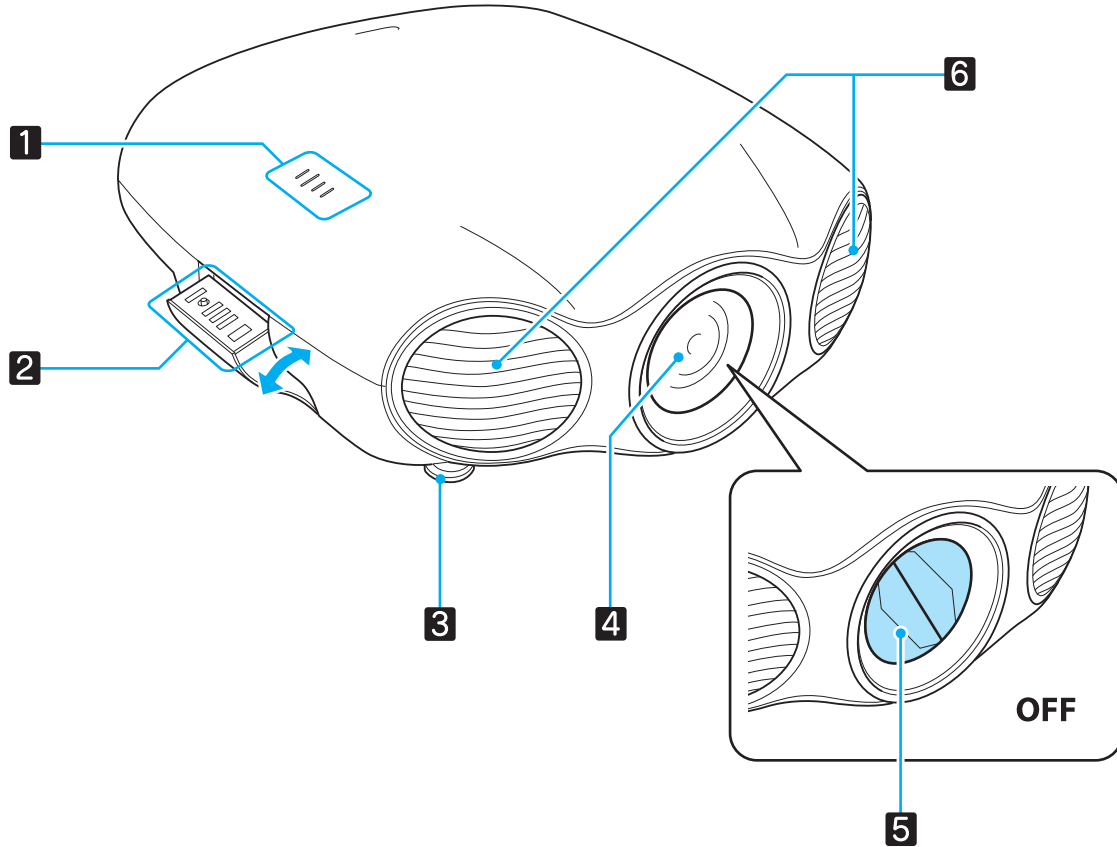

Name		Function
1	Indicators	The color of the indicators and whether they are flashing or lit indicate the status of the projector. 🖱️ p.10
2	Control panel	Retractable control panel on the side of the projector. 🖱️ p.10
3	Front adjustable foot	Adjust the projector's horizontal tilt when placing and projecting. 🖱️ p.29
4	Projector's lens	Images are projected from here. <div style="border: 1px solid black; padding: 5px; margin-top: 10px;"> <p>⚠️ Warning</p> <p>Do not look into the lens during projection.</p> </div>
5	Lens shutter	Links to the projector's power on/off function, and automatically opens and closes the shutter. 🖱️ p.25

Name	Function
6 Air exhaust vent	Exhaust vent for air used to cool the projector internally. <div style="border: 1px solid black; padding: 5px;"> <p>⚠ Caution</p> <p>While projecting, do not put your face or hands near the air exhaust vent, and do not place objects that may become warped or damaged by heat near the vent. Hot air from the air exhaust vent could cause burns, warping, or accidents to occur.</p> </div>

Rear

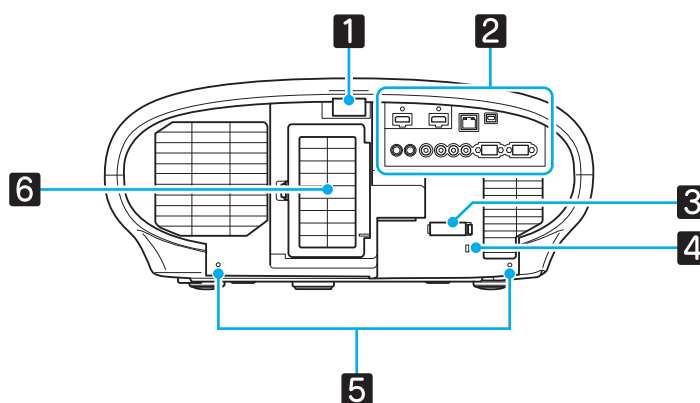

Name	Function
1 Remote receiver	Receives signals from the remote control. ➡ p.24
2 Interface panel	Provides ports and so on for connecting external equipment. ➡ p.8
3 Cable clamp	Secures the cables. ➡ p.23
4 Security slot (🔒)	The security slot compatible with the MicroSaver security system manufactured by Kensington. For more details, visit the Kensington homepage at http://www.kensington.com/ .
5 Screw holes to fix the cable cover	Screw holes to fix the cable cover in place. ➡ p.20
6 Air intake vent/Air filter cover	Intake vent for air used to cool the projector internally. When cleaning or replacing the air filter, open this cover and remove the air filter. ➡ p.94

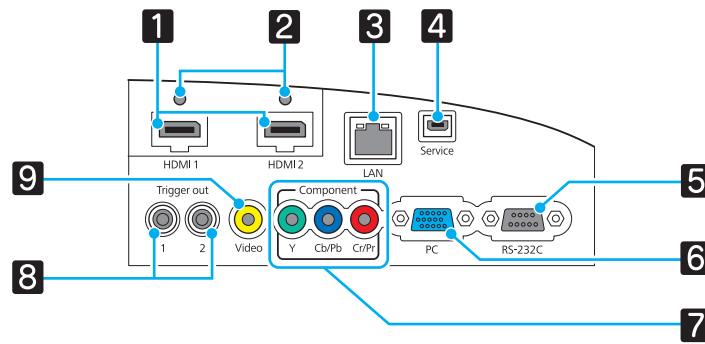

Interface

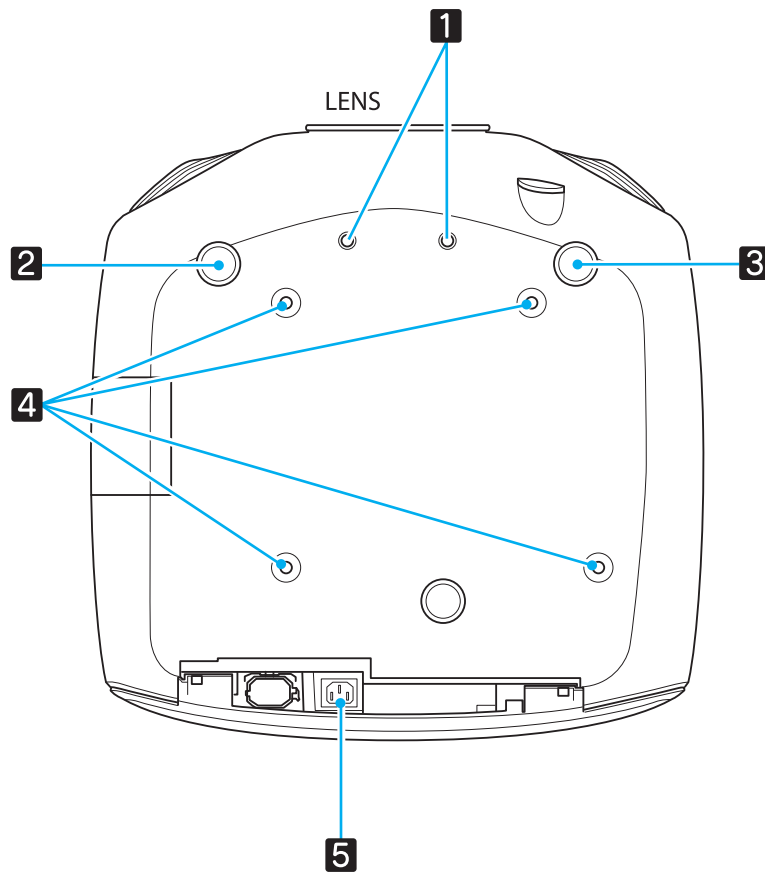

Name	Function
1 HDMI1/HDMI2 ports	Connects HDMI compatible video devices and computers. p.21 The HDMI1 port supports HDCP 2.2.
2 Cable holders	Insert the supplied HDMI cable clamp. Because thick HDMI cables with a large outer diameter, may disconnect easily due to the weight of the cable, secure the cables with the HDMI cable clamp. p.21 , p.22
3 LAN port	Connects a LAN cable to connect to a network. p.23
4 Service port	This port is a service port and should not normally be used.
5 RS-232C port	When controlling the projector, connect the projector to a computer with an RS-232C cable. This port is for control use and should not normally be used.
6 PC port	Connects to the RGB output port on a computer. p.22
7 Component ports	Connects to the component (YCbCr or YPbPr) output ports on video devices. p.21
8 Trigger out 1/Trigger out 2 ports	Connects with external devices such as motorized screens. p.22
9 Video port	Connects to the composite video output port on video devices. p.21

Base



Name		Function
1	Screw holes for anamorphic lens	Screw holes for attaching the anamorphic lens.
2	Front adjustable foot	Adjust the projector's horizontal tilt when placing and projecting.  p.29
3		
4	Ceiling mount fixing points (four points)	Attach the ceiling mount here when suspending the projector from a ceiling.
5	Power inlet	Connect the power cord to the projector.  p.25

Control Panel

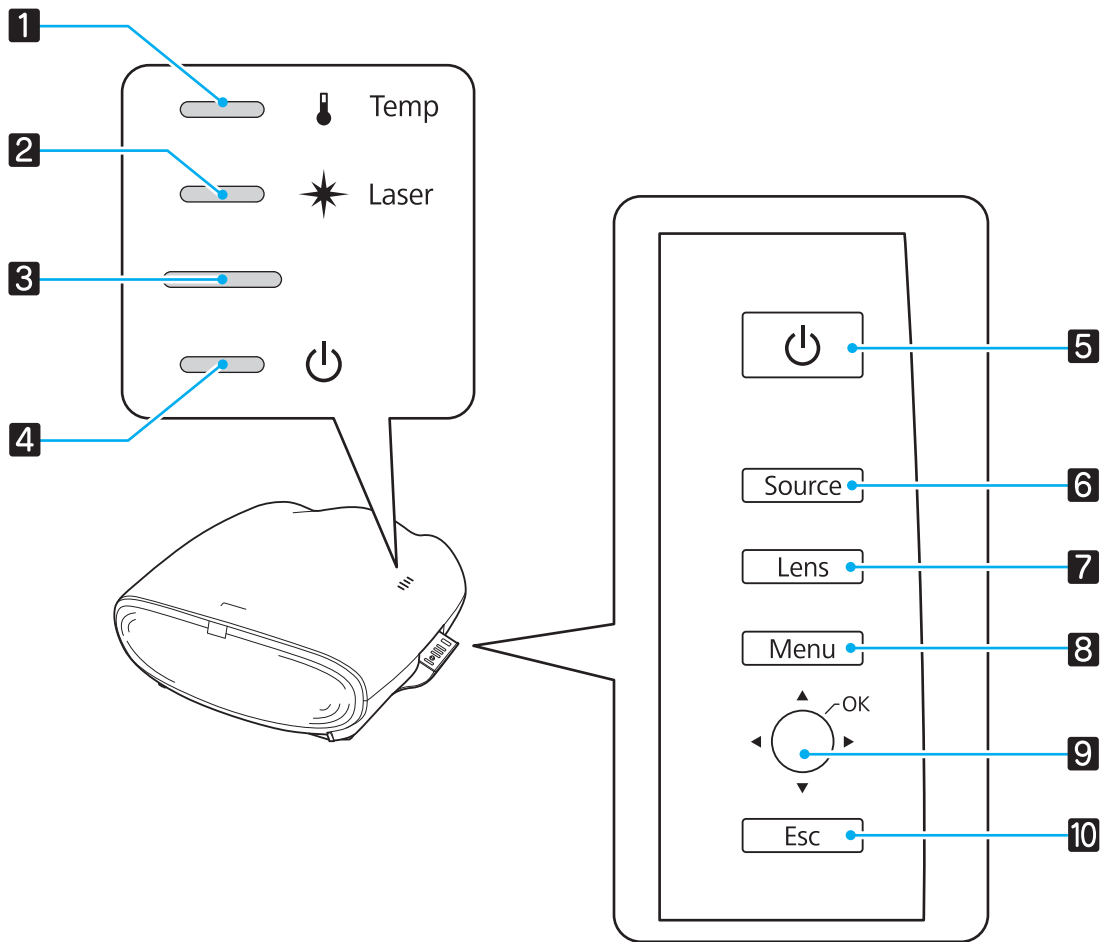

Buttons/Indicators	Function
1	Flashes orange if the internal temperature is too high. Shows the projector's errors through a combination of other indicators lit and flashing. p.83
2	Lit orange when an error occurs in the laser section. Shows the projector's errors through a combination of other indicators lit and flashing. p.83
3	Flashes to indicate warm-up in progress or cool-down in progress. Shows the projector's status through a combination of other indicators lit and flashing. p.83
4	Lit when the projector is on. Shows the projector's errors through a combination of other indicators lit and flashing. p.83
5	Turns the projector power on or off. p.25
6	Changes to the image from each input port. p.32
7	Changes the adjustment item for the motorized lens function. The following adjustment items are available. <ul style="list-style-type: none"> • Focus p.30 • Zoom p.30 • Lens shift p.31
8	Displays and closes the Configuration menu. p.27 On the Configuration menu, you can make adjustments and settings for Signal, Image, Input Signal, and so on. p.68



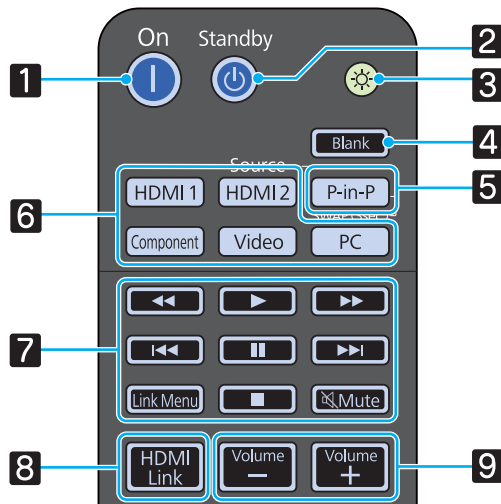

Buttons/Indicators		Function
9		Move vertically and horizontally to select the adjustment value for the Configuration menu item. p.27 Move vertically while projecting an image to correct keystone distortion. p.31
		When the Configuration menu is displayed, it accepts and enters the current selection and moves to the next level. p.27
10		When the Configuration menu is displayed, it moves to the previous menu level. p.27

Remote Control

Top section buttons

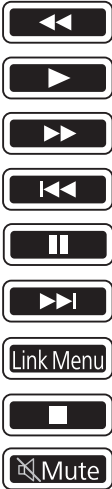



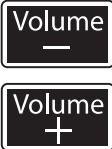



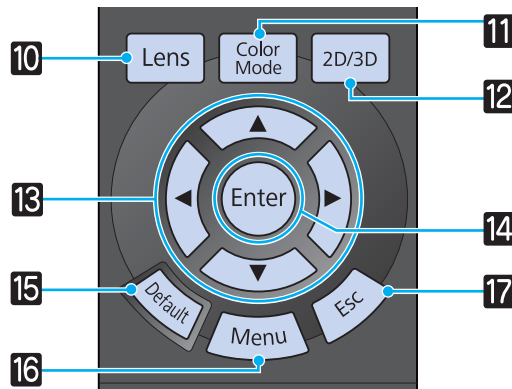





Button	Function
1 	Turns the projector on. p.25
2 	Turns the projector off. p.26
3 	The remote control buttons light up for approximately 10 seconds. This is useful when operating the remote control in the dark.
4 	Temporarily hides or shows the image. p.34 While the Configuration menu is displayed, the menu is temporarily hidden, and is displayed at the top-right of the screen.
5 	Starts or exits Picture in Picture. p.61
6 	Changes to the image from each input port. p.32

	Button	Function
7		Performs operations such as play and stop for connected devices that meet the HDMI CEC standards.  p.54
8		Displays the HDMI link settings menu.  p.54
9		Adjusts the volume for connected devices that meet the HDMI CEC standards.

Middle section buttons









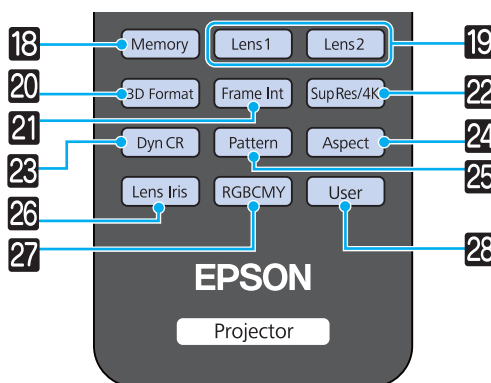

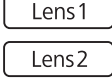
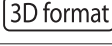
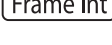
	Button	Function
10		Changes the adjustment item for the motorized lens function. The following adjustment items are available. <ul style="list-style-type: none"> • Focus  p.30 • Zoom  p.30 • Lens shift  p.31
11		Changes the Color Mode .  p.42
12		Changes between 2D and 3D images.  p.37

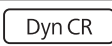
Button	Function
<p>13</p> 	<p>Selects the Configuration menu items and adjustment values. 🖱️ p.27</p>
<p>14</p> 	<p>When the Configuration menu is displayed, it accepts and enters the current selection and moves to the next level. 🖱️ p.27</p>
<p>15</p> 	<p>The adjustment value returns to its default value when pressed while the Configuration menu's adjustment screen is displayed. 🖱️ p.27</p>
<p>16</p> 	<p>Displays and closes the Configuration menu. 🖱️ p.27 On the Configuration menu, you can make adjustments and settings for Signal, Image, Input Signal, and so on. 🖱️ p.27</p>
<p>17</p> 	<p>When the Configuration menu is displayed, it moves to the previous menu level. 🖱️ p.27</p>

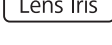
Bottom section buttons

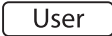

Button	Function
<p>18</p> 	<p>Saves, loads, or erases a memory, and allows you to change the name of a memory. 🖱️ p.58</p>
<p>19</p> 	<p>Loads the lens position. 🖱️ p.56</p>
<p>20</p> 	<p>Changes the 3D format. 🖱️ p.37</p>
<p>21</p> 	<p>Reduces the jarring effect caused by quick movements by interpolating frames, and adjusts to render a smoother, clearer image. 🖱️ p.46</p>
<p>22</p> 	<p>Sets Super-resolution to reduce blurring in areas such as the edges of the image, or 4K Enhancement for ultra high definition images.</p>
<p>23</p> 	<p>Sets Dynamic Contrast. 🖱️ p.45</p>
<p>24</p> 	<p>Selects the aspect mode according to the input signal. 🖱️ p.32</p>
<p>25</p> 	<p>Displays and closes the test pattern. 🖱️ p.29</p>
<p>26</p> 	<p>Lens Iris uses the lens' diaphragm to adjust the amount of light that enters the lens, which adjusts the contrast of the image. 🖱️ p.51</p>
<p>27</p> 	<p>Adjusts the hue, saturation, and brightness for each RGBCMY color. 🖱️ p.47</p>

Button		Function
28		Performs the function assigned to the user button.  p.73



Installing

Notes on Installing

Warning

Ceiling mount installations

- A special method of installation is required when suspending the projector from a ceiling (ceiling mount). If it is not installed correctly, it could fall causing an accident and injury.
- If you use adhesives, lubricants, or oil on the ceiling mount fixing points to prevent screws from loosening, or if you use things such as lubricants or oils on the projector, the projector case may crack causing it to fall from its ceiling mount. This could cause serious injury to anyone under the projector and also damage the projector.
- Do not setup the projector on its side. This may cause malfunctions to occur.
- Try not to setup the projector in locations subject to high humidity and dust, or in locations subject to smoke from fires or tobacco smoke.

Warning

About laser products

(Europe and Japan)

- This product is a class 1 laser product that conforms to IEC60825-1:2014 and JIS C 6802:2014.

(Other areas)

- This product is a class 2 laser product that conforms to IEC60825-1:2007 and GB7247-1:2012.
- Do not look into the lens during projection.
- Do not allow small children to make operations. If children do make operations, they must be accompanied by an adult.

Caution

- When lifting the projector, be careful not to drop it as it is heavy and could cause an injury.
- When installing the projector on a shelf and so on, take additional measures to prevent it from falling, such as securing with a wire. If it falls it could cause an injury.

Attention

- When lifting the projector, make sure you close the control panel.
- Do not apply excessive force to the control panel section. This may cause malfunctions to occur.
- Make sure there is at least 20 cm between the wall and the projector's air intake vent.

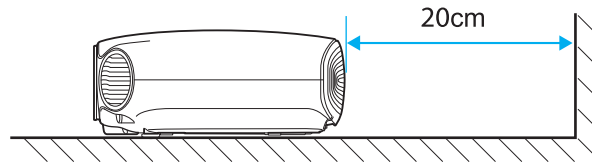

- It is recommended that you clean the air filter periodically. Clean more frequently if you are using the projector in a particularly dusty environment.  [p.94](#)

How to Install

The projector can be installed using a variety of methods, such as placing on a shelf or suspending from a ceiling. Using the lens shift function gives you more flexibility to place the projector where you want.  [p.31](#)

Placing on a shelf and projecting

You can install the projector in an AV rack or on a shelf in your living room to project images.

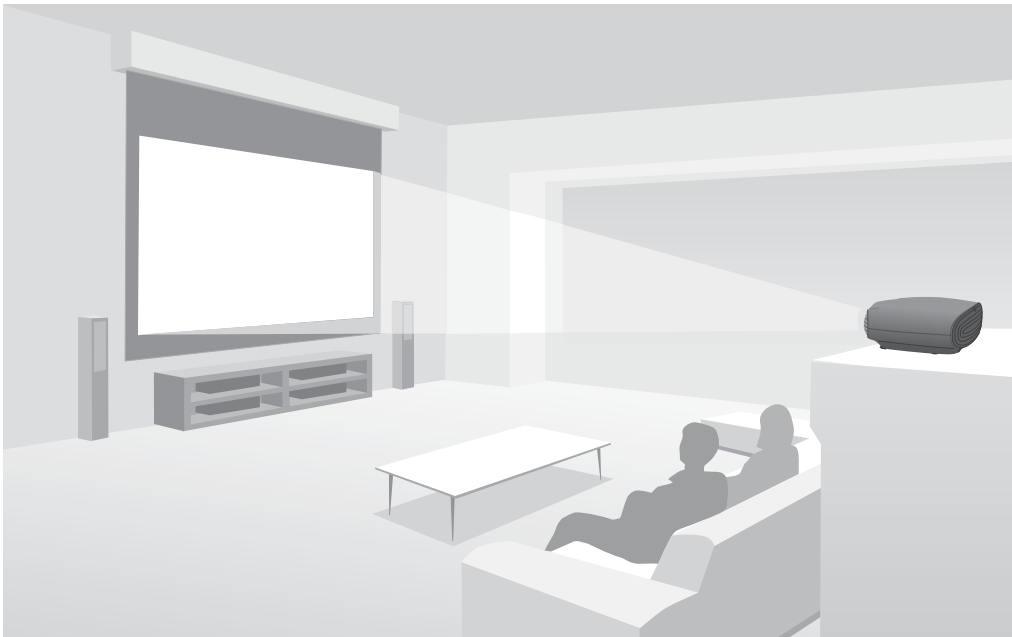

Suspending from the ceiling and projecting

You can suspend the projector from the ceiling creating a real theater-room atmosphere.

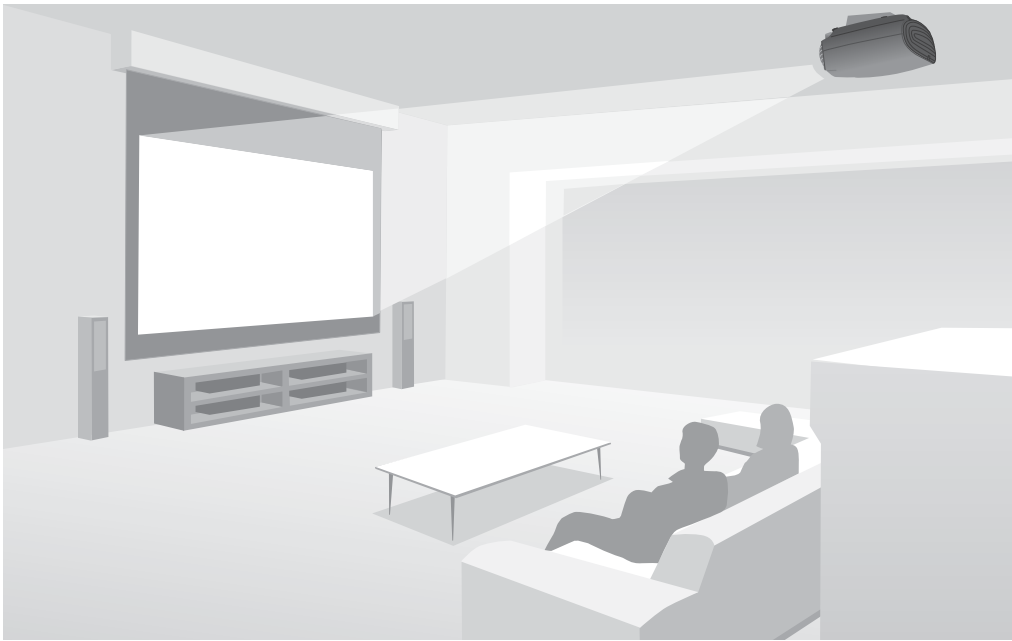

When projecting from a ceiling, change **Projection** to a ceiling setting. **Settings - Projection p.73**

Projection Distance and Lens Shift Maximum Values

The size of the projection increases as the projector is moved away from the screen. Use the following table to setup the projector so that it projects at the optimum size. The values given here are for your reference only.

You can also adjust the position by projecting using lens shift. **p.31**

The maximum lens shift adjustment values are shown in the following table.

When adjusting the projection position vertically in lens shift

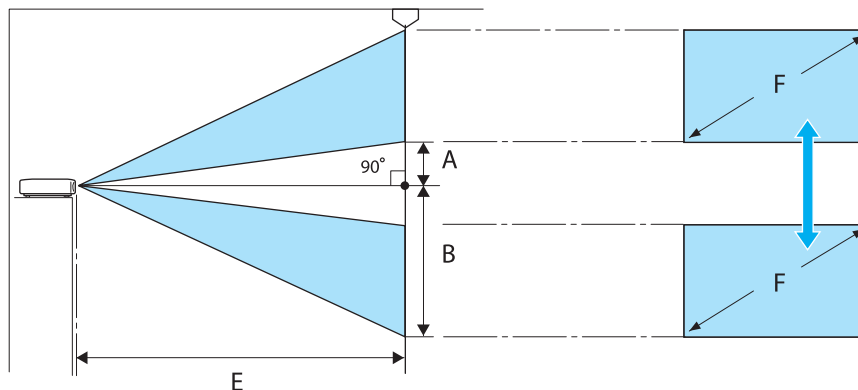

- A : Distance from the center of the lens to the bottom edge of the projected image (when lens shift is raised to its highest level)
- B : Distance from the center of the lens to the bottom edge of the projected image (when lens shift is lowered to its lowest level)
- E : Projection distance from the projector to the screen
- F : Size of the projected image

When adjusting the projection position horizontally in lens shift

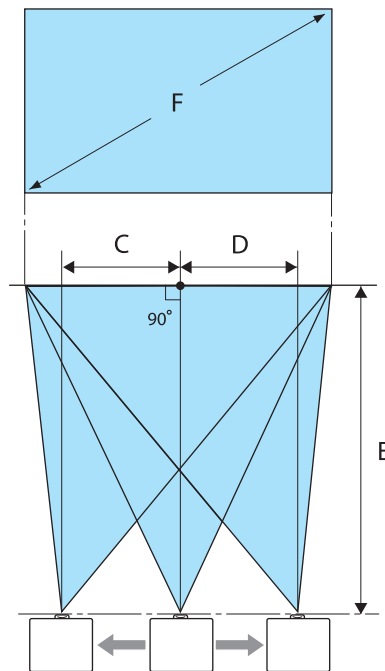

- C : Lens center movement distance when the projector is moved (when lens shift is set to maximum right)
- D : Lens center movement distance when the projector is moved (when lens shift is set to maximum left)
- E : Projection distance from the projector to the screen
- F : Size of the projected image

Unit: cm

16:9 Projected Image Size		Projection Distance (E)		Lens Shift Maximum Values*		
F	W x H	Minimum (Wide)	Maximum (Tele)	Distance (A)	Distance (B)	Distance (C, D)
40"	89 x 50	111	240	20	70	35
60"	130 x 75	169	361	30	105	53
80"	180 x 100	226	482	40	139	71
100"	220 x 120	283	604	50	174	89
120"	270 x 150	341	725	60	209	106
150"	330 x 190	427	908	75	262	133
180"	440 x 250	513	1090	90	314	159

4:3 Projected Image Size		Projection Distance (E)		Lens Shift Maximum Values*		
F	W x H	Minimum (Wide)	Maximum (Tele)	Distance (A)	Distance (B)	Distance (C, D)
40"	81 x 61	137	294	24	85	43
60"	120 x 90	207	443	37	128	65
80"	160 x 120	277	591	49	171	87
100"	200 x 150	348	740	61	213	108
120"	240 x 180	418	889	73	256	130
150"	300 x 230	523	1112	91	320	163

4:3 Projected Image Size		Projection Distance (E)		Lens Shift Maximum Values*		
F	W x H	Minimum (Wide)	Maximum (Tele)	Distance (A)	Distance (B)	Distance (C, D)
200"	410 x 300	699	1483	122	427	217

* The position of the projected image cannot be moved to the maximum horizontal and vertical values at the same time. 🖱️ [p.31](#)

Connecting a Device

Attention

- Make cable connections before connecting to a power outlet.
- Check the shape of the cable's connector and the shape of the port, and then connect. If you force a connector of a different shape into the port, it could cause damage and a malfunction to occur.

Removing the Cable Cover

You can attach the cable cover to the rear of this projector to give it a clean and smooth look. Remove the cover when connecting devices using cables, or when replacing the air filter.

- 1 Loosen the screws at the lower edges of the cable cover, and then pull it forward.

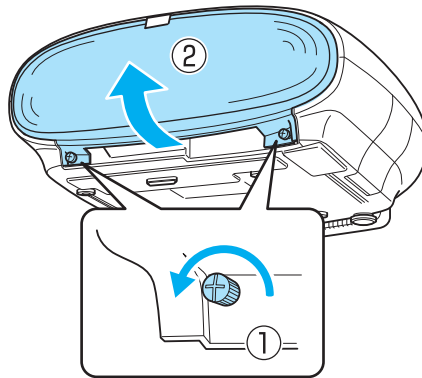

- 2 Lift the cable cover out of the grooves at the top.

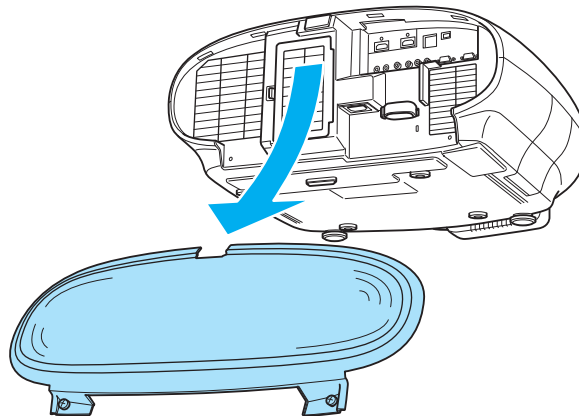

To attach the cable cover, perform this procedure in reverse.

Connecting Video Devices

To project images from Blu-ray disc players or video recorders and so on, connect to the projector using one of the following methods.



- Depending on the video device, there may be multiple types of output available. Check the documentation supplied with the video device to confirm the output types.
- This projector does not have a built-in speaker. Connect the projector to your AV system to listen to audio from connected equipment.

Equipment with HDMI output ports

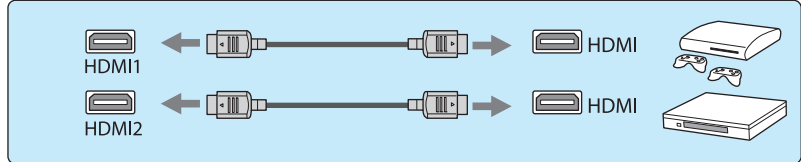
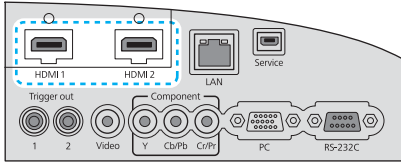

To prevent the weight of the HDMI cable disconnecting it from the port, make sure you secure it to the cable holder with the HDMI cable clamp.

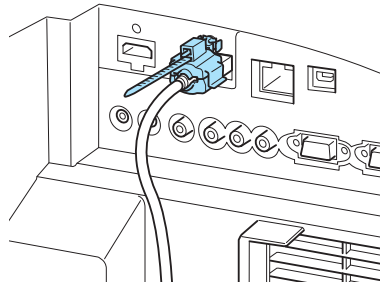

When projecting images in HDCP 2.2, connect to the HDMI1 port.

Equipment with a video output port

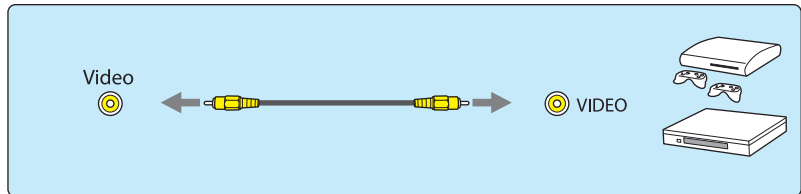
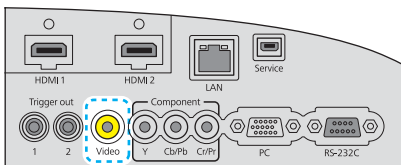

Equipment with component video output ports

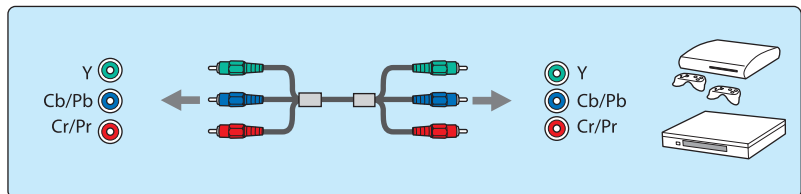
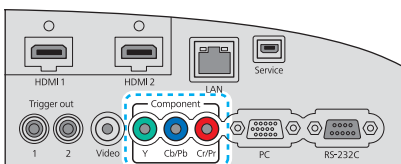

Connecting a Computer

To project images from a computer, connect the computer using one of the following methods.

Computers with an RGB output port

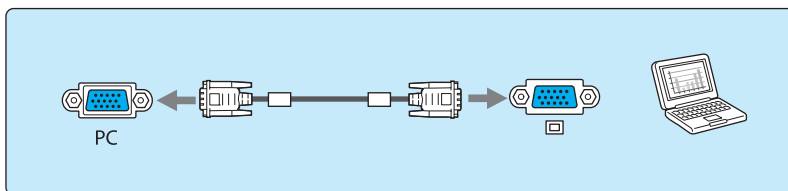
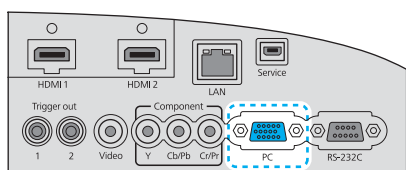

Computers with an HDMI output port

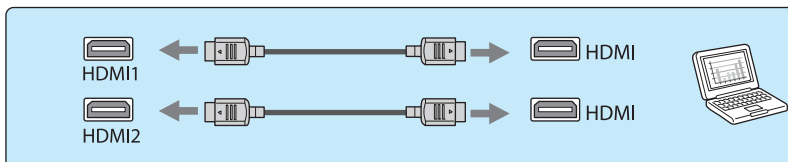
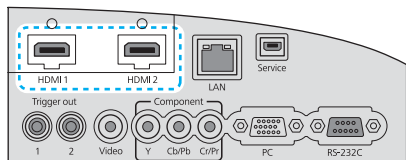

To prevent the weight of the HDMI cable disconnecting it from the port, make sure you secure it to the cable holder with the HDMI cable clamp.

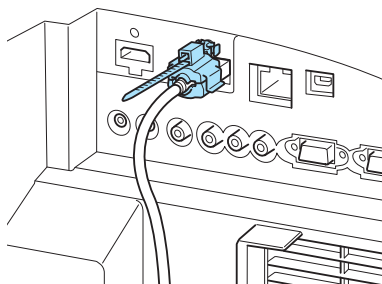

When projecting images in HDCP 2.2, connect to the HDMI1 port.

Connecting External Devices

Connecting to Trigger out 1/Trigger out 2 ports

To connect external devices such as motorized screens, connect a mini-jack stereo cable (3.5 mm).

When set to on, a signal (12 V DC) is output from this port to communicate the projector's status (on/off) to connected devices such as electric screens.

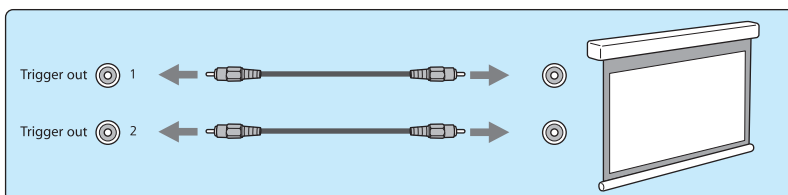
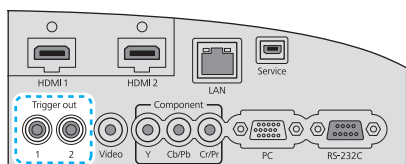

When using the Trigger out 1/Trigger out 2 ports, set Trigger Out 1/Trigger Out 2.  **Settings - Operation - Trigger Out 1/Trigger Out 2** [p.73](#)

Connecting to the LAN port

Connect to a network router, a hub, and so on, with a 100BASE-TX or 10BASE-T LAN cable.

You can operate the projector or check its status over a network from a computer or a smart device.

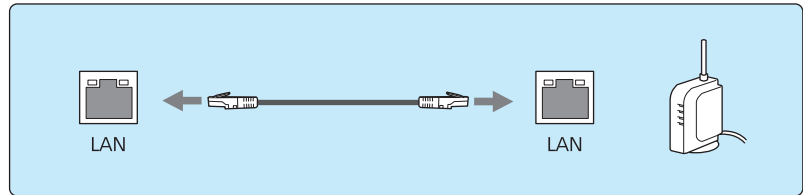
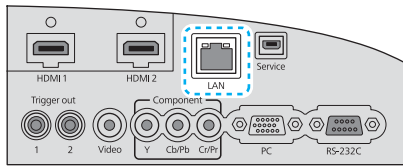

- To prevent malfunctions, use a category 5 or higher shielded LAN cable.
- You cannot project images over a network.

Securing Cables with the Cable Clamp

You can use the cable clamp to secure cables that have been connected to the projector.

1 Open the cable clamp.

Press the surface of the clamp gently with your finger to release the tab, and then pull it to swing it open.

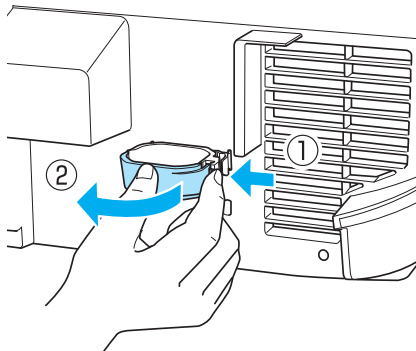

2 Gather the cables into the cable clamp.

You can gather all cables except for the power cord into the cable clamp.

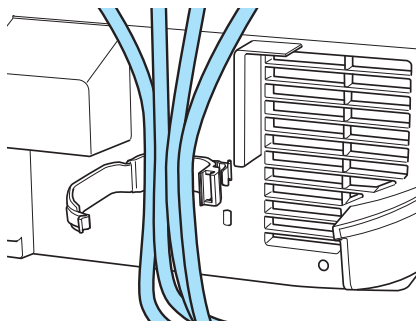

3 Close the cable clamp.

Press until the tab clicks into place.

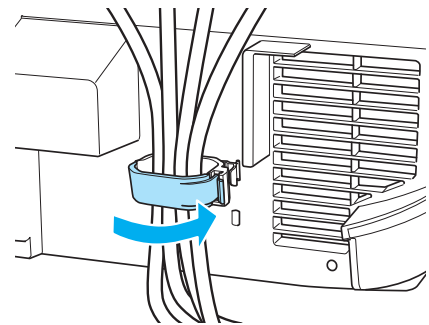



Preparing the Remote Control

Installing Batteries

Attention

- Check the positions of the (+) and (-) marks inside the battery holder to ensure the batteries are inserted the correct way.
- You cannot use other batteries except for the AA size manganese or alkaline.

- 1** Remove the battery cover.
While pushing the battery compartment cover catch, lift the cover up.

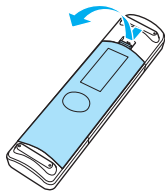

- 2** Install the batteries.
Check the polarity of the batteries (+) and (-) before installing.

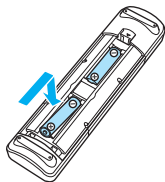

- 3** Reattach the battery cover.
Press the cover until it clicks into place.

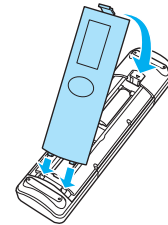

 If delays in the responsiveness of the remote control occur or if it does not operate, it probably means that the batteries are becoming flat. When this happens, replace them with new batteries. Have two AA size manganese or alkaline batteries ready.

Remote Control Operating Range

The remote control operating range is shown in the following figures.

Operating range (left to right)

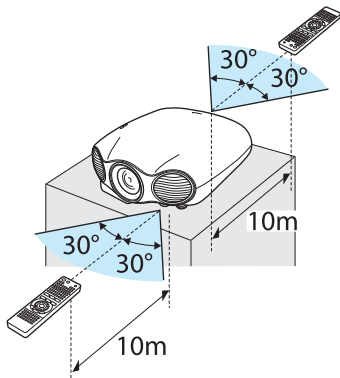

Operating range (top to bottom)

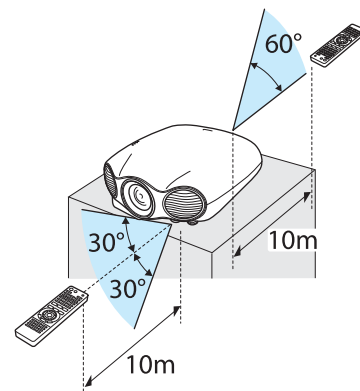

Turning the Projector On and Off

Turning On

Warning

- Do not allow small children to make operations. If children do make operations, they must be accompanied by an adult.
- Do not look into the lens during projection. Also, do not look into the lens using optical devices (such as a magnifying glass or telescope). Powerful light can damage your eyes and cause visual impairment. Families with small children should take particular care.
- When turning on the projector at a distance using the remote control, make sure there is no one looking into the lens.

- 1 Connect the equipment to the projector.
- 2 Connect the power cord.
Connect using the power cord supplied.
- 3 Turn on the connected equipment.

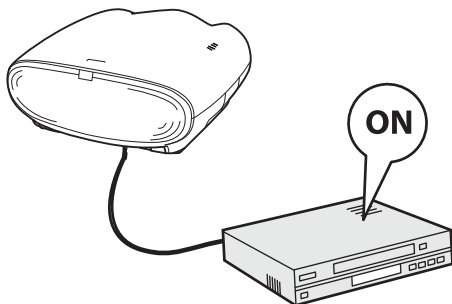

- 4 Press the button on the remote control or the control panel to turn on the projector.

Remote control

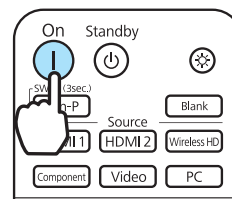

Control panel

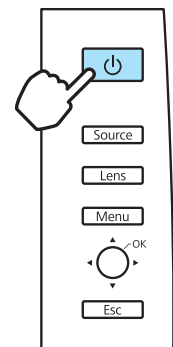

The lens shutter opens, and projection starts.



When **Direct Power On** is set to **On**, you can start projecting by simply connecting the power cord to the projector without having to press any buttons.  **Settings - Operation - Direct Power On** p.73

Attention

When using at an altitude of 1500 m or more, set **High Altitude Mode** to **On**.  **Settings - Operation - High Altitude Mode** p.73



- To obtain stable image quality, it is recommended that you leave the projector on for a while before starting operations.
- This projector provides a Child Lock function to prevent children from accidentally turning the power on and a Control Panel Lock function to prevent accidental operations. **Settings - Lock Setting - Child Lock/Control Panel Lock** p.73
- This projector comes with a Trigger out 1/Trigger out 2 ports to communicate the current status of the projector's power (on/off) to external devices. When using this function, set **Trigger Out 1/Trigger Out 2**. **Settings - Operation - Trigger Out 1/Trigger Out 2** p.73

Turning Off

1

Turn off the connected equipment.



When **Power Off Link** is set to **On** in the **HDMI Link** menu, turning off HDMI CEC compatible equipment also turns off the projector. **Settings - HDMI Link - Power Off Link** p.73

2

Press the button on the remote control or the projector's control panel.

Remote control

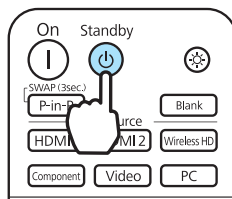

Control panel

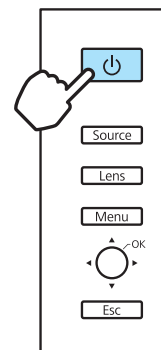

Projection ends, and the lens shutter closes automatically.



- When **Standby Confirmation** is set to **On**, a confirmation message is displayed, and the power turns off when you press the button again. **Settings - Display - Standby Confirmation** p.73
- When you turn off the projector, the operation indicator flashes for a while as the projector cools down. When the operation indicator turns off, cool-down is complete.

3

Disconnect the power cord.

Configuration Menu Operations

Using the Configuration menu, you can make adjustments and settings for images or image quality.

- For items adjusted using an adjustment bar, such as the brightness level, you can press the **Default** button while the adjustment screen is displayed to return the adjustment value to its default value.
- You can also operate the Configuration menu from the control panel.

1 Press the **Menu** button on the remote control.

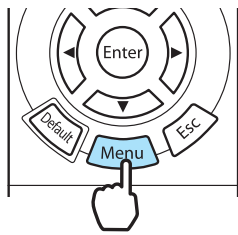

The Configuration menu is displayed.

2 Use the **Up** and **Down** buttons to select the top menu on the left, and then press the **Enter** button to confirm the selection.

When you select the top menu on the left, the sub menu on the right changes.

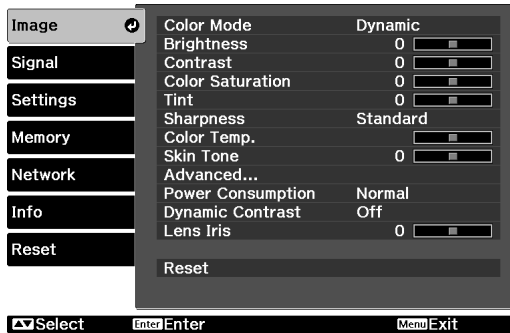

The line at the bottom is a guide for operations.

3 Use the **Up** and **Down** buttons to select the sub menu on the right, and then press the **Enter** button to confirm the selection.

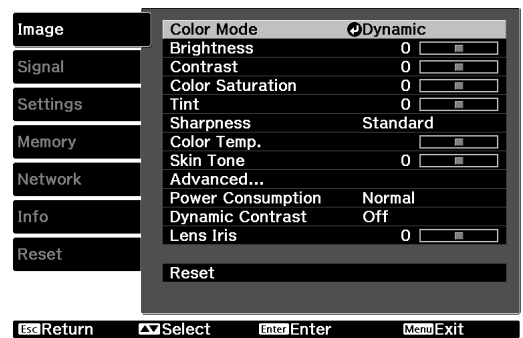

The adjustment screen for the selected function is displayed.

4 Use the **Left**, **Right**, **Up**, and **Down** buttons to adjust the settings.

Ex.) Adjustment bar



Ex.) Choices

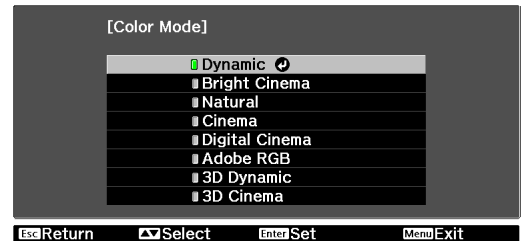

Press the **Enter** button on an item displaying this **Enter** icon to change to the selection screen for that item.

Press the **Esc** button to return to the previous level.

5

Press the  button to exit the menu.

Adjusting the Projected Screen

Displaying the Test Pattern

Immediately after installation, a test pattern is used to adjust the zoom, focus, and the projection position. Press the **Pattern** button on the remote control to display the test pattern.



You can also select patterns that display R (red), G (green), and B (blue) individually, as well as the pattern for adjusting the display position. You can use it as a pattern to perform color adjustment when an image signal is being input.

Press the **Esc** button or select **Exit** to end the test pattern display.

Adjusting the Projector's Tilt

If the projected image is tilted (the left and right sides of the projector are at different heights) when the projector is setup on a shelf, adjust the front foot so that both sides are level with each other.

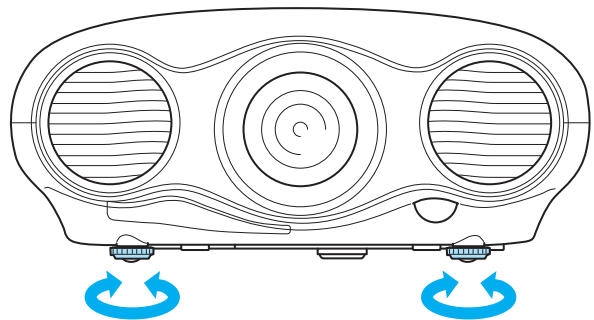

Lens Adjustment Function (Focus, Zoom, Lens Shift)

To adjust the focus, zoom, or lens shift, press the **Lens** button on the remote control or the control panel, and then select the item you want to adjust.

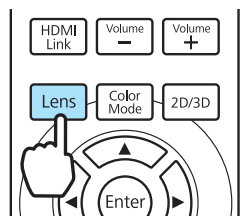





The adjustment items switch as shown in the following table.

1	Focus adjustment	Adjust Focus is displayed on the screen. Adjusts the focus of the projected image. p.30
2	Zoom adjustment	Adjust Zoom is displayed on the screen. Adjusts the size of the projected image. p.30

3	Lens shift adjustment	Adjust Lens Shift is displayed on the screen. Adjusts the position of the projected image.  p.31
---	-----------------------	---

To finish making adjustments, press the Lens button in Lens shift adjustment.



- Using the lens position function, you can save and load lens adjustment positions.
- When you select **Adjust Lens Shift** and the following message is displayed, the image position is adjusted in the opposite direction to the lens shift using the     buttons.

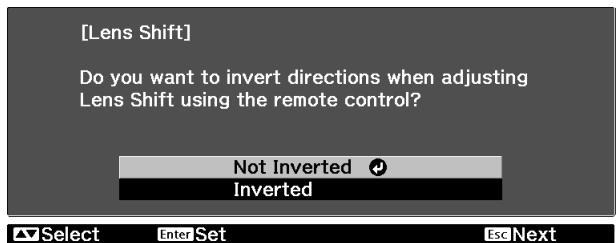

If you make the following selections in **Projection** settings, the image is adjusted in the same direction as the buttons.  **Settings - Projection** [p.73](#)

Front, Rear: Not Inverted



Front/Ceiling, Rear/Ceiling: Inverted

■ Adjusting the focus

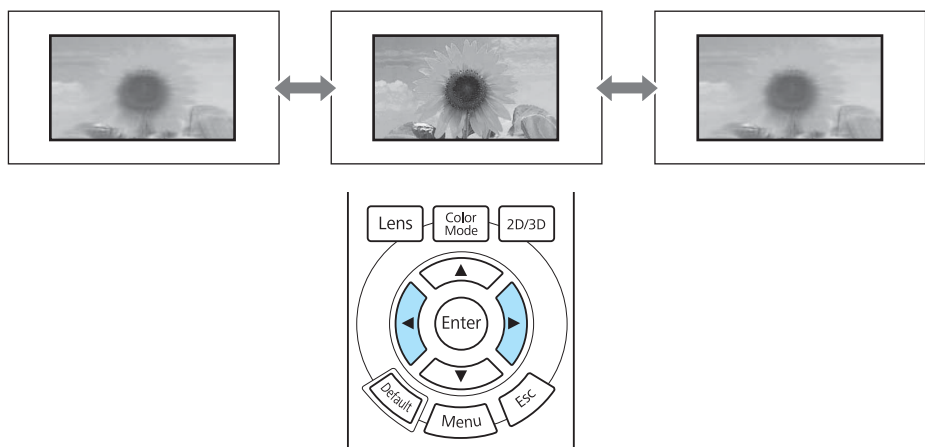
Press the   buttons to adjust the focus.



■ Adjusting the projection size (zoom adjustment)

Press the   buttons to adjust the size of the projected screen.

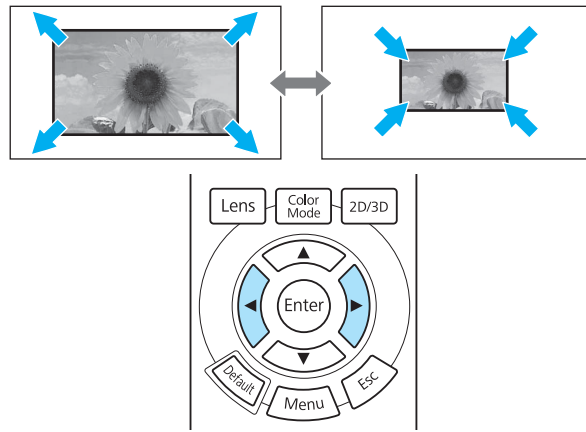

Adjusting the position of the projected image (lens shift)

If the projector cannot be setup in front of the screen, you can adjust the position of the image by using lens shift.

Use the buttons to adjust the position of the image.

Hold down the buttons to return to the center position.

You can move the image within the range indicated by the dotted line in the figure on the right.

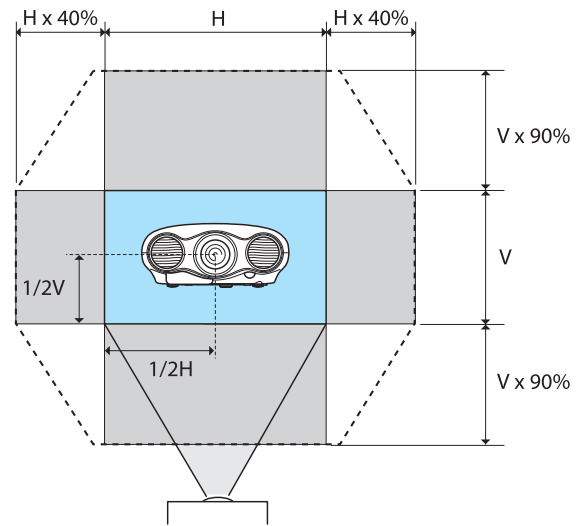

Caution
 When transporting the projector, set the vertical and horizontal lens positions to the center. If you transport the projector when the lens is shifted up, down, left, or right, the lens shift mechanism could be damaged.

When you cannot install the projector directly in front of the screen, it is recommended that you use lens shift to adjust the projection position. If you cannot adjust using lens shift, try using keystone correction.

Keystone

You can use the button on the control panel to correct keystone distortion.

Move the button up or down to display the adjustment gauges.

When the gauges are displayed, move the button up or down to perform vertical correction.

When the top or bottom is too wide

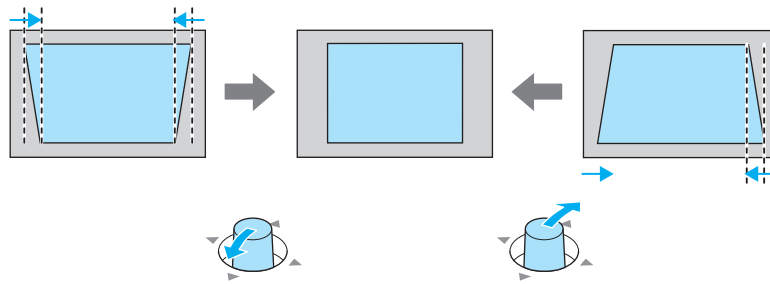

- The projected screen becomes smaller when correcting keystone distortion. Increase the projection distance to fit the projected screen to the screen size.
- You can make keystone settings from the Configuration menu. **Settings - Keystone p.73**
- You can make effective corrections within a projection angle of 30° top to bottom.
- For position adjustment, you can maintain the quality of the projected image by performing correction using lens shift. Use keystone when you cannot make adjustments using lens shift.

Switching the Source

You can change the source using the following method.

Press the button for the target port.

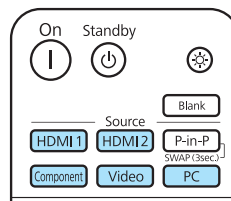

- You can also change the source by pressing the **Source** button on the control panel.
- For video devices, start playback first and then change the source.
- If the color looks unnatural when changing to a **Video** or **Component** source, check that the port you have connected to is the same as the **Input Signal**. **Settings - Input Signal - Video Signal/Component p.73**

Aspect

You can change the input signal's type, aspect ratio, and resolution to match the **Aspect** of the projection screen.

The available **Aspect** varies depending on the image signal currently being projected.



Note that using the aspect ratio function of the projector to reduce, enlarge, or split the projected image for commercial purposes or for public viewing may infringe upon the rights of the copyright holder of that image based on copyright law.

1 Press the **Aspect** button.

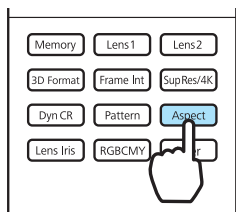

You can make settings from the Configuration menu. **Signal - Aspect p.70**

2 Use the buttons to select the setting name, and then press the **Enter** button to confirm the selection.

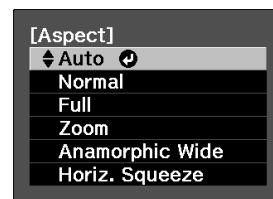

Aspect may not be available depending on the type of signal.

By normally selecting Auto, the optimum aspect is used to display the input signal. Change the setting if you want to use a different aspect.

The table below shows the image projected on a 16:9 screen.

Input Image	Setting Name (Aspect)		
	Normal	Full	Zoom
4:3 images			
16:9 images		When projecting 16:9 images, Full and Zoom cannot be selected.	
Images recorded using squeeze			
Letterbox images*			
Notes	Matches the vertical size of the projection panel. The aspect ratio differs depending on the input image.	Uses the entire projection panel.	Retains the aspect ratio of the input signal, and matches the horizontal size of the projection panel. The top and bottom of the image may be truncated.

* The letterbox image used in this explanation is a 4:3 aspect ratio image displayed in 16:9 with black margins at the top and bottom for subtitle placement. The margins at the top and bottom of the screen image are used for subtitles.

With this projector you can also set **Anamorphic Wide** and **Horiz. Squeeze**.

Set **Anamorphic Wide** and attach a commercially available anamorphic lens to enjoy DVDs, Blu-rays, and so on of images recorded at Cinema Scope size.

Horiz. Squeeze stretches the horizontal aspect of the input signal. This allows you to project across the full width of the screen when using a commercially available anamorphic lens.







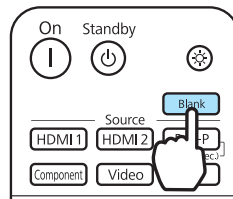

- If **Anamorphic Wide** is selected when **Overscan** is set, the image may be truncated. Set **Overscan** to **Off**.  **Signal - Advanced - Overscan** p.70
- When projecting 3D images in **Anamorphic Wide**, only 1080p/24 Hz/frame packing signals are supported.
- When a 4K image signal is being input, you can only select **Normal**, **Anamorphic Wide**, and **Horiz. Squeeze**.

Hiding the Image Temporarily

You can use this to temporarily hide the image on the screen.

Press the  button to show or hide the image.



- Because moving images continue to play even when they are hidden, you cannot return to the point at which you hid the images using the  button.
- If the  button is pressed while the Configuration menu is displayed, the menu is temporarily hidden, and  is displayed at the top-right of the screen.
- If you press the  button on the remote control or the control panel while the image is hidden, a confirmation message is displayed asking if you want to turn off the projector. Press the  button again to turn off the projector.



Viewing 3D Images

This projector allows you to view 3D images using 3D Glasses.



- Since the 3D Glasses use the active shutter method, they need to be charged in advance. [p.38](#)
- You also need to pair the 3D Glasses with the projector in advance. [p.39](#)

Warnings Regarding Viewing 3D Images

Note the following important points when viewing 3D images.



Warning

Disassembling or remodeling

- Do not disassemble or remodel the 3D Glasses.
This could cause a fire to occur or the images to appear abnormal when viewing, causing you to feel unwell.

Storage locations

- Do not leave the 3D Glasses or the supplied parts within reach of children.
If they are not handled correctly, they could cause an injury.

Wireless (Bluetooth) communication

- Electromagnetic interference may cause medical equipment to malfunction. Before using the device, make sure there is no medical equipment in the vicinity.
- Electromagnetic interference may cause automatically controlled equipment to malfunction which could cause an accident. Do not use the device near automatically controlled equipment such as automatic doors or fire alarms.

Heating

- Do not place the 3D Glasses in a fire, on a heat source, or leave them unattended in a location subject to high temperatures. Because this device has a built-in rechargeable lithium battery, it could cause burns or a fire if it ignites or explodes.

Charging

- When charging, connect the supplied cable to the USB port designated by Epson. Do not charge using other devices as it may cause the battery to leak, overheat, or explode.
- Only use the supplied charging cable to charge the 3D Glasses. Otherwise, it could overheat, ignite, or explode.



Caution

3D Glasses

- Do not drop or press too forcefully on the 3D Glasses.
If the glass sections and so on are broken, an injury could occur. Store the glasses in the soft glasses case.
- Be careful of the edges of the frame when wearing the 3D Glasses.
If it pokes your eye and so on, an injury could occur.
- Do not place your finger in any of the moving sections (such as the hinges) of the 3D Glasses.
Otherwise an injury could occur.

 **Caution**

Wearing 3D Glasses

- Make sure you wear the 3D Glasses correctly.
Do not wear the 3D Glasses upside down.
If the image is not displayed correctly into the right and left eyes, it could cause you to feel unwell.
- Do not wear the glasses unless you are viewing a 3D image.
- How a 3D image is perceived varies depending on the individual. Stop using the 3D function if you feel strange or cannot see in 3D.
Continuing to view the 3D images could cause you to feel unwell.
- Stop wearing the 3D Glasses immediately if they seem abnormal or a malfunction occurs.
Continuing to wear the 3D Glasses could cause an injury or cause you to feel unwell.
- Stop wearing the 3D Glasses if your ears, nose, or temples become red, painful, or itchy.
Continuing to wear the 3D Glasses could cause you to feel unwell.
- Stop wearing the 3D Glasses if your skin feels unusual when wearing the glasses.
In some very rare cases the paint or materials used in the 3D Glasses could cause an allergic reaction.

 **Caution**

Viewing time

- When viewing 3D images, always take periodic breaks during extended viewing.
Long periods of viewing 3D images may cause eye fatigue.
The amount of time and frequency of such breaks varies from person to person. If your eyes still feel tired or uncomfortable even after taking a break from viewing, stop viewing immediately.

 **Caution**

Watching 3D images

- If your eyes feel fatigued or uncomfortable when viewing 3D images, stop viewing immediately.
Continuing to view the 3D images could cause you to feel unwell.
- When viewing 3D images be sure to always wear 3D Glasses. Do not attempt to view 3D images without 3D Glasses.
Doing so could cause you to feel unwell.
- Do not place any breakable or fragile objects around you when using 3D Glasses.
3D images may cause you to move your body involuntarily, resulting in damage to nearby items or personal injury.
- Only wear 3D Glasses when viewing 3D images. Do not move around while wearing 3D Glasses.
Your vision may appear darker than normal, causing you to fall or injure yourself.
- Try to stay as level with the viewing screen as possible when viewing 3D images.
Viewing 3D images at an angle reduces the 3D effect and may cause you to feel unwell due to unintended color changes.
- If using 3D Glasses in a room with fluorescent or LED lighting, you may see flashing or flickering throughout the room. If this should occur, reduce the lighting until the flickering goes away or turn off the lights completely when viewing 3D images. In some very rare cases, this flickering could trigger seizures or fainting for some individuals. If you begin to feel uncomfortable or unwell at any time when viewing 3D images, stop immediately.
- Stay at least three times the height of the screen away from the screen when viewing 3D images.
The recommended viewing distance for an 80-inch screen is at least 3 meters, and at least 3.6 meters for a 100-inch screen.
Sitting or standing any closer than the recommended viewing distance may result in eye fatigue.

 **Caution**

Health risks

- You should not use 3D Glasses if you are sensitive to light, have a heart condition, or are unwell. Doing so could aggravate your pre-existing conditions.

 **Caution**

Recommended age of use

- The minimum recommended age to view 3D images is six years old.
- Children under the age of six are still developing and viewing 3D images may cause complications. Consult your doctor if you have any concerns.
- Children viewing 3D images through 3D Glasses should always be accompanied by an adult. It is often difficult to tell when a child is feeling tired or uncomfortable, which could result in them feeling suddenly unwell. Always check with your child to ensure that they are not experiencing any eye fatigue during viewing.

Projecting 3D Images

You can view 3D images only from devices connected to the HDMI1/HDMI2 ports.

The projector supports following 3D formats.

- Frame packing
- Side by side
- Top and bottom



Depending on the device, 3D image signals may not be output correctly.

When the projector detects a 3D format

The projector automatically projects a 3D image when detecting a 3D format.

When the projector cannot detect a 3D format

Some 3D TV broadcasts may not contain 3D format signals. If this happens, set the 3D format manually. Press the  button to set the 3D format on the AV device.

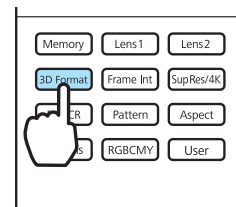

- For details on 3D format settings on the AV device, see the documentation supplied with the AV device.
- When the 3D format has not been set up correctly, the same image is split horizontally or vertically and is not projected correctly as shown below.

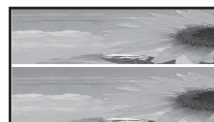
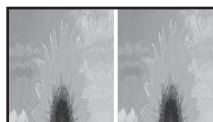

■ If the 3D image cannot be viewed

Check the following if the 3D effect is not applied correctly, even after setting the 3D formats.

- The synchronization timing for the 3D Glasses may have been inversed. Inverse the synchronization using **Inverse 3D Glasses**, and then try again. 🗨 **Signal - 3D Setup - Inverse 3D Glasses** p.70
- The image is not displayed in 3D if **3D Display** is set to **Off**. Press the  button on the remote control. 🗨 **Signal - 3D Setup - 3D Display** p.70



- How a 3D image is perceived varies depending on the individual.
- When a 3D image is displayed, a warning about viewing 3D images is displayed. You can turn off this warning by setting **3D Viewing Notice** to **Off**. 🗨 **Signal - 3D Setup - 3D Viewing Notice** p.70
- You can also convert 2D images to 3D images. 🗨 p.40
- During 3D image projection, the following Configuration menu functions cannot be changed. Aspect (set to Normal*), Noise Reduction (set to Off), Overscan (set to Off), Advanced - Sharpness, Picture in Picture
 - * You can select Anamorphic Wide only when 1080p/24 Hz/frame packing signals are projected.
- How the 3D image is viewed may change depending on the temperature of the surroundings. Refrain from using the projector if the image is not projected normally.

Preparing the 3D Glasses

Use 3D Glasses to view 3D images.



The 3D Glasses come with protective stickers. Remove the protective stickers before use.

■ Charging the 3D Glasses

Charge using the optional USB Charging Adapter.

Charging using the USB Charging Adapter

Use the USB cable to connect the 3D Glasses to the USB Charging Adapter, and then connect the USB Charging Adapter to an electrical outlet.

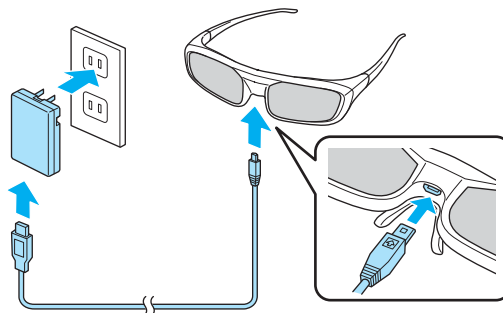

Attention

- Only connect to an electrical outlet that uses the voltage displayed on the adapter.
- Note the following points when handling the supplied microUSB cable.
 - You should not bend, twist, or pull the cable with too much force.
 - You should not modify the cable.
 - You should not perform wiring near an electric heater.
 - You should not use the cable if it is damaged.

■ Pairing 3D Glasses

To view 3D images, the 3D Glasses need to be paired with the projector.

Press the [Pairing] button for a while on the 3D Glasses to start pairing. See the User's Guide for the 3D Glasses for more information.



- For 3D Glasses that have not been used, pairing is performed when the 3D Glasses are turned on. You do not need to perform pairing if 3D images can already be viewed correctly.
- Once pairing has been performed, you can view 3D images the next time the devices are turned on.
- You can perform pairing within a range of three meters from the projector. While pairing is being performed, make sure you stay within a range of three meters from the projector. Otherwise, pairing may not be performed correctly.
- If synchronization cannot be performed within 30 seconds, pairing is automatically canceled. When pairing is cancelled, 3D images cannot be viewed because pairing fails.

■ Wearing and viewing with the 3D Glasses

- 1 Turn on the 3D Glasses by sliding the [Power] switch to On.

The indicator turns on for several seconds, and then turns off.

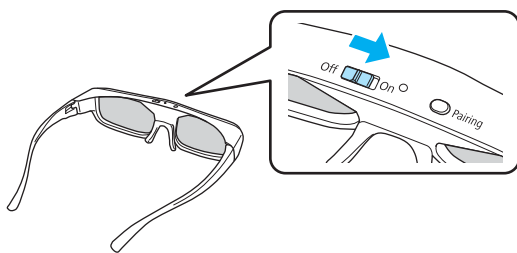

- 2 Put on the 3D Glasses and enjoy the show.



- When you have finished using the 3D Glasses, turn them off by sliding the [Power] switch to Off.
- If the 3D Glasses are not used for at least 30 seconds, they turn off automatically. To turn the 3D Glasses back on, slide the [Power] switch to Off, and then slide it back to On.
- You need more pairs of 3D Glasses if more than one person will be viewing the 3D image.

 [p.97](#)

Range for Viewing 3D Images

This projector allows you to view 3D images within the range shown in the figure below.

You can view 3D images within a range of 10 m from the projector.

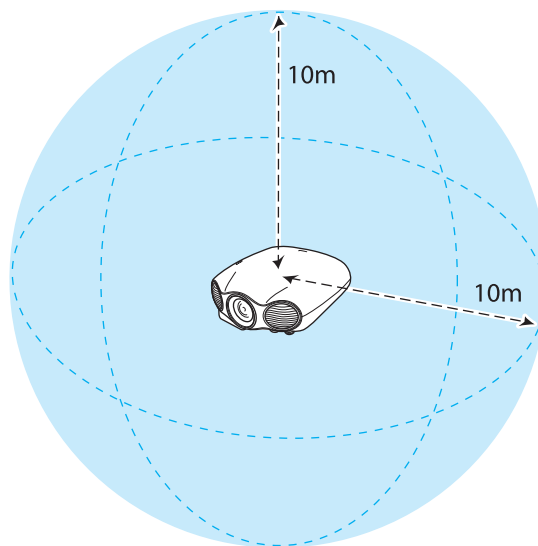

- 3D images may not be displayed correctly if there is any interference from other Bluetooth communication devices. Do not use these devices at the same time.
- The communication method for 3D Glasses uses the same frequency (2.4 GHz) as wireless LAN (IEEE802.11b/g) or microwave ovens. Therefore, if these devices are used at the same time, radio wave interference may occur, the image may be interrupted, or communication may not be possible. If you do need to use these devices at the same time, make sure there is enough distance between them and the projector.

Converting 2D Images to 3D Images and Viewing

You can convert 2D images being input to the HDMI1/HDMI2 ports to 3D images.

- 1 Press the **Menu** button, select **Signal - 3D Setup** from the Configuration menu, and then press the **Enter** button to confirm the selection.

The **3D Setup** screen is displayed.

- 2 Select **2D-to-3D Conversion**, and then press the **Enter** button to confirm the selection.

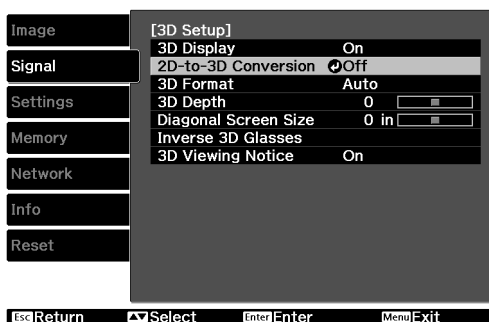

- 3 Select the strength of the 3D effect, and then press the **Enter** button to confirm the selection.

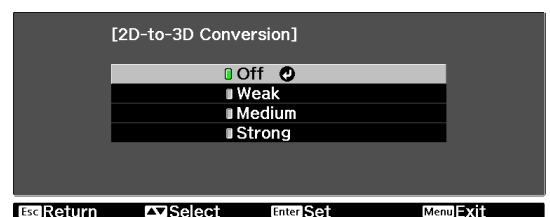

- 4 Press the **Menu** button to exit the menu.



When **3D Display** is set to **Off**, press the **2D/3D** button on the remote control after making settings.



- When using **2D-to-3D Conversion**, set **3D Format** to **Auto** or **2D**. 🖱️ **Signal - 3D Setup - 3D Format** [p.70](#)
- This cannot be set when **Image Processing** is set to **Fast** in the **Signal** menu. 🖱️ **Signal - Advanced - Image Processing** [p.70](#)

Basic

Color Mode

You can obtain the optimum image quality to suit your surroundings when projecting. The brightness of the image varies depending on the mode selected.

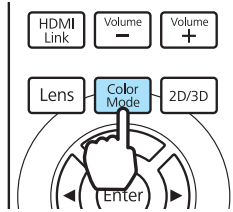

1 Press the  button.



You can make settings from the Configuration menu.  **Image - Color Mode** [p.68](#)

2

Select **Color Mode**.

Press the   buttons from the displayed menu to select **Color Mode**, and then press the  button to confirm the selection.

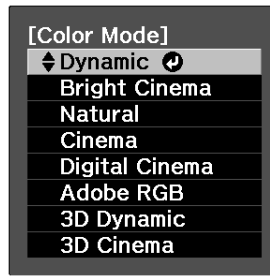

The following color modes are available.

- ✓ : Available
- : Grayed out and unavailable

Mode	Projected Image		Application
	2D	3D	
Dynamic	✓	-	This is the brightest mode. Best for prioritizing brightness.
Bright Cinema	✓	-	Best for projecting vivid images.
Natural	✓	-	Best for faithfully reproducing the color of the source image. We recommend selecting this mode when performing color adjustment for the image.
Cinema	✓	-	Best for enjoying content such as movies.
Digital Cinema	✓	-	Projects images in the Digital Cinema color space. Best for prioritizing colors.
Adobe RGB	✓	-	Projects using the Adobe RGB color space. Ideal when the color profile of the image is Adobe RGB.
3D Dynamic	-	✓	A dedicated 3D mode best for prioritizing brightness.
3D Cinema	-	✓	A dedicated 3D mode best for enjoying content such as movies.

Super-resolution/4K Enhancement

There are two types of setting available, Super-resolution and 4K Enhancement.



When a low resolution image is input to the projector, it is increased to 1920 x 1080 pixels. Super-resolution sharpens blurred images, enhancing the apparent detail of the image by increasing the resolution of the image signal.

4K Enhancement projects 4K images (3840 x 2160 pixels) using "4K Enhancement Technology", employing super resolution processing and creating ultra high definition images.

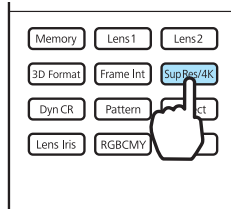

1

Press the  button.



- You can make settings from the Configuration menu.  **Signal - Super-resolution/4K** p.70
- This cannot be set when a computer image signal is being input.
- This cannot be set when converting 2D images to 3D images.  **Signal - 3D Setup - 2D-to-3D Conversion** p.70
- How the image is viewed may change depending on the temperature of the surroundings. It is recommended that you leave the projector on for a while before performing operations.

2

Use the   buttons to select the item, and then press the  button to confirm the selection.

Select **1** to **5** when setting the super-resolution.

Select **4K-1** to **4K-5** when projecting 4K images and setting super-resolution.

The higher the item number, the stronger the effect.



- Depending on the image, distortion at the edge of the image may be enhanced. If you notice any distortion, set another item.
- **4K Enhancement** cannot be set when projecting 3D images. **Super-resolution** is enabled only for 1080p/24 Hz/frame packing signals.
- **1** to **5** cannot be set when a 4K image signal is being input.
- **4K-1** to **4K-5** cannot be selected when **Image Processing** is set to **Fast**. Set **Fine**.  **Signal - Advanced - Image Processing** p.70

3

Press the  button to exit the menu.





The following restrictions apply when projecting a 4K image.

- **Aspect:** Only **Normal**, **Anamorphic Wide**, and **Horiz. Squeeze** are available
- **Frame Interpolation:** Only available when a 1080p/24 Hz signal is input, and fixed at **Off** when other signals are being input
- **Image Processing:** Fixed at **Fine**

Detail Enhancement





This function enhances details in an image to create clear outlines.

- 1 Press the  button, select **Signal - Detail Enhancement** from the Configuration menu, and then press the  button to confirm the selection.

The **Detail Enhancement** adjustment screen is displayed.





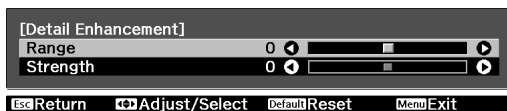

- This cannot be set when a computer image or a 4K image signal are being input.
- This cannot be set when converting 2D images to 3D images. ➔ **Signal - 3D Setup - 2D-to-3D Conversion** p.70
- When projecting 3D images, this setting is enabled only for 1080p/24 Hz/frame packing signals.

- 2 Use the   buttons to select **Range**, and then use the   buttons to make the adjustments.

The higher the number, the wider the range from the outline area effected by the enhancement.



- 3 Use the   buttons to select **Strength**, and then use the   buttons to make the adjustments.

The higher the number the stronger the outlines are enhanced.

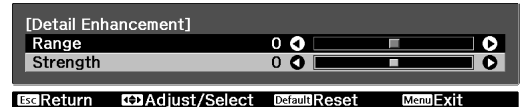

- 4 Press the  button to exit the menu.

Dynamic Contrast



By automatically setting the luminance according to the brightness of the displayed image, it lets you enjoy deep and rich images.

You can select the luminance adjustment tracking for changes in brightness in the displayed image from **Normal** to **High Speed**.

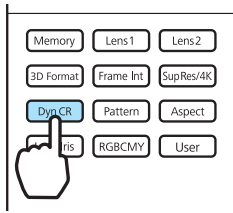
1 Press the **Dyn CR** button.



You can make settings from the Configuration menu. **Image - Dynamic Contrast** p.68

2 Use the   buttons to select the item, and then press the **Enter** button to confirm the selection.

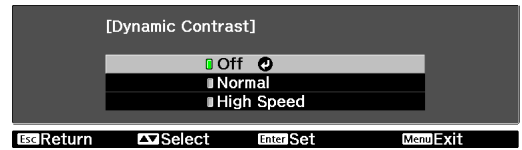

3 Press the **Dyn CR** button to exit the menu.

Frame Interpolation



This setting compares the current and previous frames, and then creates a frame between them to create smooth images even for movies with a quick frame rate.

You can select the level of interpolation from **Low**, **Normal**, or **High**.

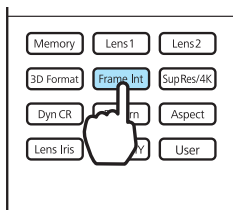
1 Press the **Frame Int** button.



- You can make settings from the Configuration menu. **Signal - Frame Interpolation** p.70
- This cannot be set when **Image Processing** is set to **Fast** in the **Signal** menu. **Signal - Advanced - Image Processing** p.70
- This cannot be set when a computer image signal is being input.
- When projecting 3D images and when **Super-resolution/4K** from the **Signal** menu is set to **4K**, this setting is only available for 1080p/24 Hz signals. **Signal - Super-resolution/4K** p.70

2 Use the   buttons to select the item, and then press the **Enter** button to confirm the selection.

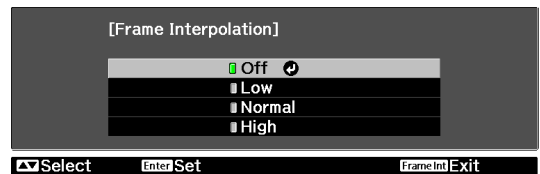

- If you notice any distortion after changing the setting, set it to **Off**.
- When a 4K image signal is being input, this setting is fixed at **Off**, and **Low**, **Normal**, and **High** cannot be set.

3 Press the **Frame Int** button to exit the menu.

Precise Image Adjustment

Hue, Saturation, and Brightness

You can adjust the hue, saturation, and brightness for each of the R (red), G (green), B (blue), C (cyan), M (magenta), and Y (yellow) colors.

Hue	Adjusts the overall color of the image to be blue, green, or red.
Saturation	Adjusts the overall vividness of the image.
Brightness	Adjusts the overall color brightness of the image.

1 Press the **RGBCMY** button.

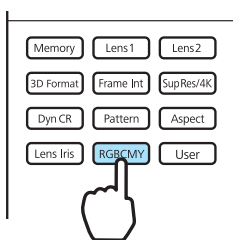

You can make settings from the Configuration menu. **Image - Advanced - RGBCMY p.68**

2 Use the buttons to select the color you want to adjust, and then press the button to confirm the selection.

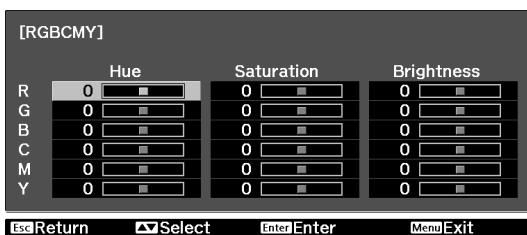

3 Use the buttons to select **Hue, Saturation, or Brightness**.

4 Use the buttons to make adjustments.

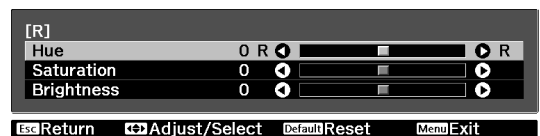

Press the button to adjust another color.

Press the button to return the adjustments to their default values.

5 Press the **RGBCMY** button to exit the menu.

Gamma

You can adjust slight coloration differences that may occur due to the device being used when the image is displayed.

You can use one of the following three methods selected from the Configuration menu.

Setting Method	Menu Settings
Select and adjust the correction value	Image - Advanced - Gamma
Adjust while viewing the image	Image - Advanced - Gamma - Customized - Adjust it from the image

Setting Method	Menu Settings
Adjust using the gamma adjustment graph	Image - Advanced - Gamma - Customized - Adjust it from the graph

■ Select and adjust the correction value

Select the adjustment value, and then press the  button to confirm the selection.

The larger the value, the lighter the dark portions of the image become, but bright areas may appear discolored. The upper part of the gamma adjustment graph becomes rounded.

The smaller the value, the darker the bright portions of the image become. The lower part of the gamma adjustment graph becomes rounded.

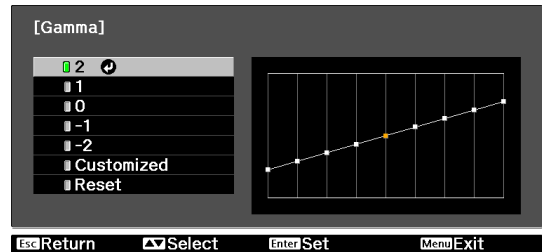

- The horizontal axis of the gamma adjustment graph shows the input signal level, and the vertical axis shows the output signal level.
- Press the  button to return the adjustments to their default values.



■ Adjust while viewing the image

Select a point on the image where you want to adjust the brightness, and adjust only the selected tone.

1 Move the gamma icon displayed on the image being projected to the area for which you want to adjust the brightness, and then press the  button.



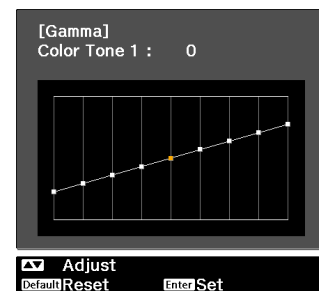

The gamma adjustment graph is displayed.

2 Use the   buttons to adjust the brightness, and then press the  button to confirm the selection.





■ Adjust using the gamma adjustment graph

Select a tone point on the graph and make adjustments.

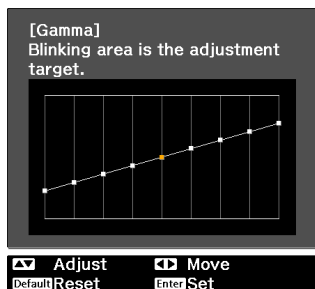
- 1 Use the   buttons to select the part you want to adjust from the graph.



- 2 Use the   buttons to adjust the brightness, and then press the  button to confirm the selection.

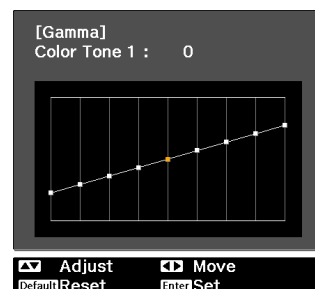





RGB (Offset/Gain)

For the image's brightness, you can adjust the dark areas (Offset) and the bright areas (Gain) for R (red), G (green), and B (blue). Increase the number to brighten the image, and decrease the number to darken the image.



Offset	When the image is made brighter, shading for the darker sections is more vividly expressed. When the image is made darker, the image appears more full-bodied but shading for the darker sections is harder to distinguish.
Gain	When the image is made brighter, the bright sections become whiter and shading is lost. When the image is made darker, shading for the bright sections is more vividly expressed.

The menu is displayed in the following order.

Image - Advanced - RGB

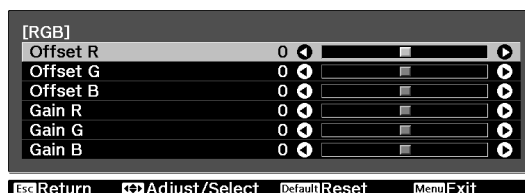
Use the   buttons to select the item, and then use the   buttons to make the adjustments.





 Press the  button to return the adjustments to their default values.

Color Temp.

You can adjust the color temperature. Make adjustments if the image is a little too blue or too red.

The menu is displayed in the following order.

Image - Color Temp.

Use the   buttons to make adjustments. Blue tints grow stronger as the value is increased, and red tints grow stronger as the value is reduced.

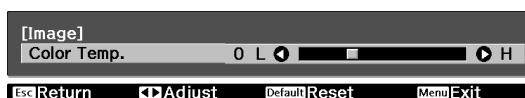



- The **Color Temp.** setting varies with the **Color Mode** setting.
- Press the  button to return the adjustments to their default values.

Skin Tone

You can adjust the skin tone. Make adjustments if the skin tone is too red or too green.

The menu is displayed in the following order.

Image - Skin Tone

Use the   buttons to make adjustments.

Increase the number to make colors greener, and decrease the number to make colors redder.

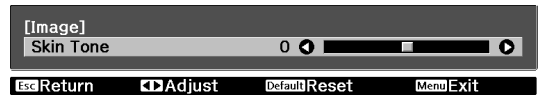

Press the  button to return the adjustments to their default values.

Sharpness



You can make the image clearer. There are two types available, **Standard** and **Advanced** which allows you to make more detailed adjustments.

Advanced cannot be adjusted in the following situations.

- When a computer signal is being input
- When **Image Processing** is set to **Fast** in the **Signal** menu
- When projecting 3D images

The following shows the setting items and procedures for **Advanced**.





Thin Line Enhancement	Details such as hair and patterns on clothing are enhanced.
Thick Line Enhancement	Rough parts such as outlines for entire subjects or the background are enhanced, making the overall image clearer.
Vert. Line Enhancement	Enhances the image horizontally or vertically.
Horiz. Line Enhancement	

1 Press the  button, select **Image - Sharpness** from the Configuration menu, and then press the  button to confirm the selection.

The **Sharpness** adjustment screen is displayed.

2 Select **Advanced** at the top right of the screen, and then press the  button to confirm the selection.

The **Advanced** adjustment screen is displayed.

3 Use the   buttons to select the item, and then use the   buttons to make the adjustments.

The image is enhanced when moved to the right (positive) and softer when moved to the left (negative).

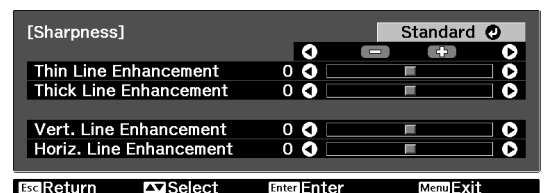

The upper bar adjusts high and low areas simultaneously.

Press the  button to return the adjustments to their default values.

- Press the  button to exit the menu.



Lens Iris

Reduces the amount of light in the projection lens and adjusts the brightness of the image.

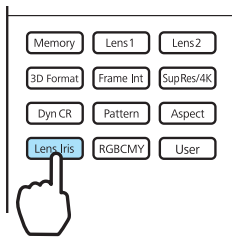

Unlike dynamic contrast that automatically adjusts the amount of light according to the brightness of the image, this allows you to adjust the amount of light for images with a lot of bright scenes.

- Press the  button.



 You can make settings from the Configuration menu.  **Image - Lens Iris** [p.68](#)



- Press the  button to exit the menu.

- Use the   buttons to make adjustments.

By lowering the number, the images become vivid.



Press the  button to return the adjustments to their default values.

 The default values and settings differ depending on the **Color Mode** settings and zoom lens position.  **Image - Color Mode** [p.68](#)

Panel Alignment

Adjusts the pixel color shift of the LCD display.





- When projecting using lens shift to adjust the position of the image, once you have adjusted to a suitable position, perform panel alignment.  [p.31](#)
- Panel alignment cannot be performed correctly when projecting using extreme keystone correction. Install the projector in a position that does not require keystone correction.

1 Press the **Menu** button, select **Settings - Panel Alignment** from the Configuration menu, and then press the **Enter** button to confirm the selection.

The **Panel Alignment** adjustment screen is displayed.

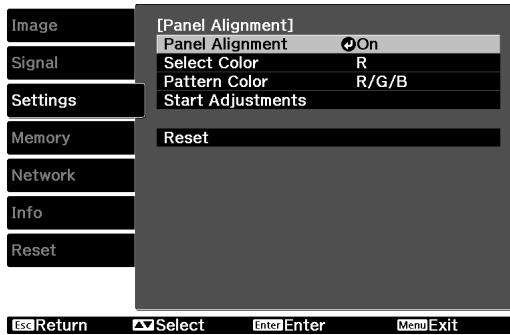
2 Set **Panel Alignment** to **On**.



 When set to **On**, the adjusted value is enabled. When set to **Off**, the corrected value returns to the default value.





3 In **Select Color**, select the color you want to adjust.

4 Select the grid color displayed when making adjustments from **Pattern Color**.

Select **Pattern Color**, and then press the **Enter** button.



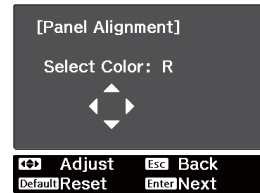

5 Select **Start Adjustments**, and then press the **Enter** button to confirm the selection.

First, adjust the entire LCD display. If a start confirmation message is displayed, press the **Enter** button to start adjustment.

6 Use the     buttons for adjustments, and then press the **Enter** button.



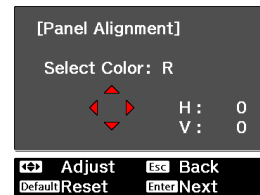

7 When performing more detailed adjustments, select **Adjust the four corners** and press the **Enter** button to confirm the selection.

8 Use     buttons to adjust, and then press the **Enter** button to move to the next adjustment point.

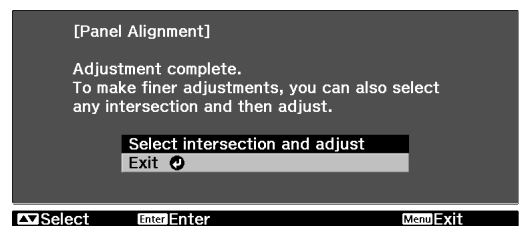

9 After adjusting four corners, select **Exit**, and then press the **Enter** button to confirm.





 If the four corners still need adjustments, select **Select intersection and adjust**, and then continue adjustments.

10 Press the **Menu** button to exit the menu.



Image Processing

Improves the image quality or response speed for projected images.

This is only available when receiving a progressive signal input from the Component, Video, HDMI1, or HDMI2 ports.

- 1 Press the  button, select **Signal - Advanced - Image Processing** from the Configuration menu, and then press the  button to confirm the selection.

The **Image Processing** adjustment screen is displayed.

- 2 Use the   buttons to select the item, and then press the  button to confirm the selection.

Fine: Improves the image quality.

Fast: Improves the response speed.



- 3 Press the  button to exit the menu.



- In the following situations, this is fixed at **Fine** and grayed out.
 - When a 3D image is being input
 - When a 4K image signal is being input
- When **Image Processing** is set to **Fast**, the following settings are applied and menu items are grayed out.
 - **Noise Reduction, Frame Interpolation, 2D-to-3D Conversion:** Fixed at **Off**
 - **Sharpness - Advanced, Super-resolution/4K - 4K:** Unavailable
- When **Super-resolution/4K** is set to **4K**, and **Image Processing** is set to **Fast**, a message is displayed informing you that 4K Enhancement has been cancelled. Select **Yes**, and set **Super-resolution/4K** to **Off**. If you select **No**, the screen displayed in step 2 is displayed again.
- When a signal is being input with a refresh rate of 24 Hz or 30 Hz, the **Fine** setting is used.

HDMI Link

HDMI Link Function

When an AV device that meets the HDMI CEC standards is connected to the projector's HDMI1/HDMI2 ports, you can perform linked operations such as linked power on and volume adjustment for the AV system from one remote control.



- Connect with a high-speed HDMI cable.
- As long as the AV device meets the HDMI CEC standards, you can use the HDMI link function even if the AV system in-between does not meet the HDMI CEC standards.
- Some connected devices or functions of those devices may not operate properly even if they meet the HDMI CEC standards. See the documentation and so on supplied with the connected device for more information.

Connection example

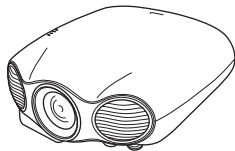

Projector



HDMI

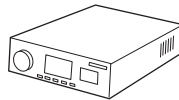

Amplifier



HDMI

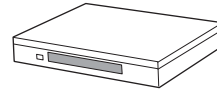

Multi-media players and so on

HDMI Link Settings

By pressing the button on the remote control, and setting **HDMI Link** to **On**, you can operate the following functions. [p.73](#)

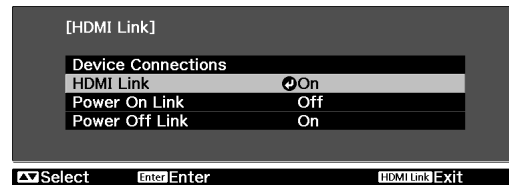

Function	Explanation
Power on link	Powers on the projector when content is played back on the connected device. Or, powers on the connected device when the projector is turned on.
Power off link	Powers off the connected device when the projector is turned off. <ul style="list-style-type: none"> • This only works when the connected device's CEC power link function is enabled. • Note that depending on the status of the connected device (for example, if it is recording), the device may not power off.
Input change link	Changes the input source of the projector to HDMI when content is played back on the connected device.
Connected devices operations	You can perform operations such as Play, Stop, Fast Forward, Rewind, Next Chapter, Previous Chapter, and Pause from the remote control for the projector.



To use the HDMI Link function, you must configure the connected device. See the documentation supplied with the connected device for more information.

Selecting the Connected Device

Display a list of the devices that can be operated with the HDMI link function, and then select the device you want to use.

1

Press the  button, and then select **Device Connections**.

The **Device Connections** list is displayed.

Devices that have a green icon to their left are linked.

If the device name cannot be determined this field is left blank.



Only one AV amplifier is recognized. If multiple amplifiers are connected, the amplifier recognized first is displayed.

2

Select the device you want to operate using the HDMI Link function.

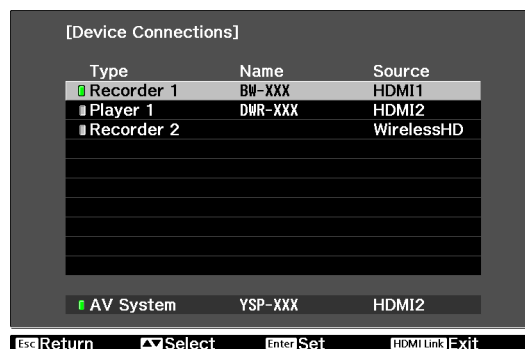

Lens Position Function

You can save the focus, zoom, and lens shift positions for lens adjustment.

This allows you to load a saved lens position to quickly set the lens to the optimum projection position.



For example, you can easily load a lens position that was saved while projecting on a cinema scope screen, or when multiple screens with different aspects were being used.

Saving the Lens Position

1 Adjust the focus, zoom, and lens shift to the status you want to save.

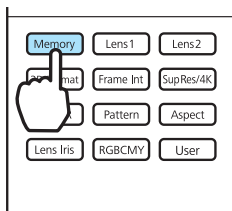

2 Press the **Memory** button.

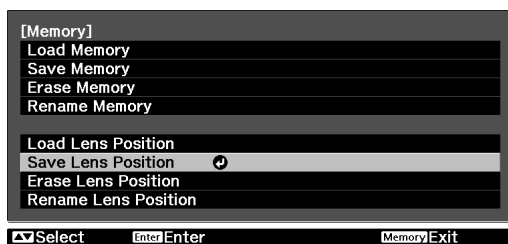

3 Use the   buttons to select **Save Lens Position**, and then press the **Enter** button to confirm the selection.



The **Save Lens Position** screen is displayed.

4 Use the   buttons to select the lens position name to be saved, and then press the **Enter** button to confirm the selection.

The adjustment values are saved.

If the mark on the left of the lens position name is turned green, it means the lens position has already been registered. When you select a registered lens position, a message is displayed asking you to confirm that you want to overwrite the lens position. If you select **Yes**, the previous settings are deleted and the current settings are registered.



- You can save up to 10 lens positions.
- If you save to **Memory1** or **Memory2**, you can load the settings by pressing the **Lens1** or **Lens2** button on the remote control.

Loading the Lens Position



1 Press the **Memory** button, and then select **Load Lens Position**.
The **Load Lens Position** screen is displayed.

2 Select the lens position name you want to load.

The zoom, focus, and lens shift are adjusted to the status you saved.

While adjustments are being performed, a message is displayed and the projector cannot be operated.



- If you have saved to **Memory1** or **Memory2**, you can load the settings by pressing the  or  button on the remote control.
- This does not guarantee that the saved status will be completely restored. Errors could occur.

Erasing the Lens Position

1 Press the button, and then select **Erase Lens Position**.

The **Erase Lens Position** screen is displayed.

2 Select the lens position name you want to erase.

A confirmation message is displayed. Select **Yes** to erase the content of the saved memory.



If you want to erase all of the saved lens positions, go to **Reset - Reset Lens Position** on the Configuration menu.  [p.82](#)

Renaming the Lens Position

You can change the lens position name using up to 12 characters. Giving the memory a name that is easy to remember is useful when loading the memory.





1 Press the button, and then select **Rename Lens Position**.

The **Rename Lens Position** screen is displayed.

2 Select the lens position name you want to change.

3 Enter a name.

The soft keyboard is displayed.  [p.80](#)

Use the     buttons to select a character, and then press the  button to confirm the selection. Enter up to 12 characters.

When you have finished, select **Finish**.

The lens position name is changed.

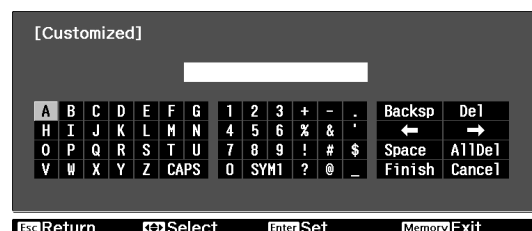

Memory Function

Settings that can be Saved

You can save some settings for the Configuration menu (Save Memory).

By saving settings, you can load settings made for specific images or scenes from the remote control (Load Memory).

You can save the following Configuration menu settings.

Image 👉 p.68	Color Mode, Power Consumption, Brightness, Contrast, Color Saturation, Tint, Sharpness, Color Temp., Skin Tone, Dynamic Contrast	
	Advanced	Sharpness, Offset, Gain, Gamma, Hue, Saturation, Brightness, EPSON Super White
Signal 👉 p.70	Deinterlacing, Motion Detection, Super-resolution/4K, Detail Enhancement	
	Advanced	Noise Reduction, Setup Level, Overscan, HDMI Video Range

Saving the Memory

1 Make settings that you want to save to the Configuration menu.

2 Press the **Memory** button.

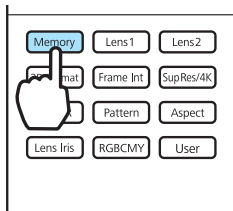

3 Use the buttons to select **Save Memory**, and then press the button to confirm the selection.

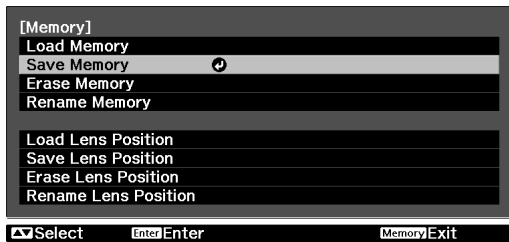

The **Save Memory** screen is displayed.

4 Use the buttons to select the memory name to be saved, and then press the button to confirm the selection.

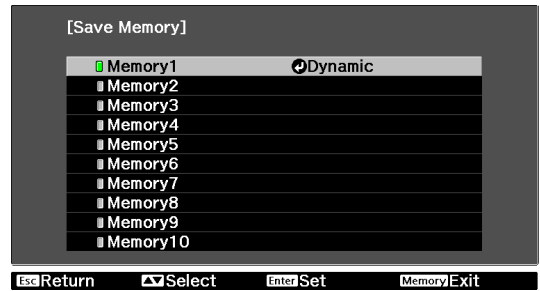

The current projector settings are saved as a memory.

If the mark on the left of the memory name is turned green, it means the memory has already been registered. When you select a registered memory, a message is displayed asking you to confirm that you want to overwrite the memory. If you select **Yes**, the previous settings are deleted and the current settings are registered.

You can save up to 10 memories.

Loading the Memory

- 1 Press the  button, and then select **Load Memory**.
The **Load Memory** screen is displayed.

- 2 Select the memory name you want to load.



- The color mode saved to the memory is displayed on the right.
- Depending on the input signal, part of the loaded memory item may not be applied to the projected image.
- Memories saved for 2D images can only be loaded when projecting 2D images. Memories saved for 3D images can only be loaded when projecting 3D images. Unavailable memory names are grayed out and cannot be selected.

Erasing the Saved Memory

- 1 Press the  button, and then select **Erase Memory**.
The **Erase Memory** screen is displayed.

- 2 Select the memory name you want to erase.
A confirmation message is displayed. Select **Yes** to erase the content of the saved memory.



You can erase all of saved memories from **Reset - Reset Memory** on the Configuration menu.
 [p.82](#)

Renaming the Memory





You can change the memory name using up to 12 characters. Giving the memory a name that is easy to remember is useful when loading the memory.

- 1 Press the  button, and then select **Rename Memory**.
The **Rename Memory** screen is displayed.

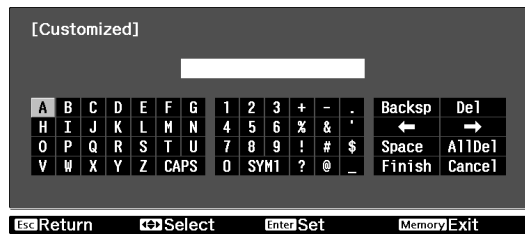
- 2 Select the memory name you want to change.

- 3** Select from the list of names, or enter a name of your own.
 If you select from the name list, check that the memory name has been changed.
 To enter a name of your own, select **Customized**, and then enter the name using the soft keyboard.
 🖱️ p.80



Use the     buttons to select a character, and then press the  button to confirm the selection. Enter up to 12 characters.

When you have finished, select **Finish**.

The memory name is changed.

Picture in Picture

In Picture in Picture, two different image sources can be projected, one in the main screen (large screen) and the other in the sub screen (small screen).

Types of Screen that can be Displayed Simultaneously

HDMI1 and HDMI2 are examples of input sources that can be displayed in Picture in Picture.

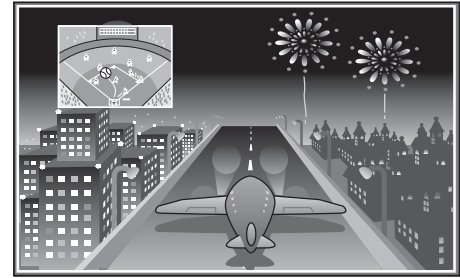

Combinations of input sources for Picture in Picture projection

Main Screen	Sub Screen
HDMI1	HDMI2
HDMI2	HDMI1

The projector uses InstaPrevue Technology from Silicon Image, Inc.

Starting and Exiting Picture in Picture

Starting

Press the **P-in-P** button on the remote control while the projector is projecting.

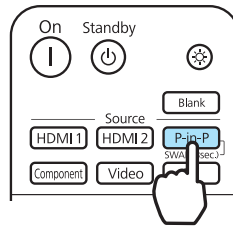

The currently input image is displayed on a Picture in Picture.

Main screen: The current image

Sub screen: The source different from the main screen



Exiting

Press the **P-in-P** button to exit.

- If the source being input is not supported, nothing is displayed in Picture in Picture.
- You cannot use Picture in Picture display to project 3D images or 4K images.
- If a 3D image or a 4K image is input during Picture in Picture display, the Picture in Picture function exits.

Picture in Picture Settings

Use the **Picture in Picture** menu to change the size or position of the sub screen.

- 1 Press the  button, select **Settings - Picture in Picture** from the Configuration menu, and then press the  button to confirm the selection.

The **Picture in Picture** menu is displayed.



The **Picture in Picture** menu is displayed directly by pressing the  button during Picture in Picture projection.

- 2 Make settings for each of the displayed functions.

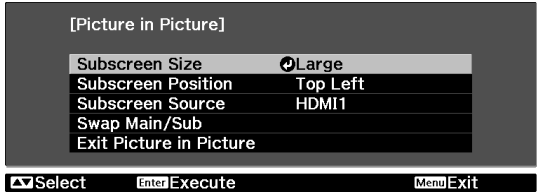

Available functions on the **Picture in Picture** menu

Function	Explanation
Subscreen Size	Selects the sub screen size using Small and Large .
Subscreen Position	Changes the sub screen position using Top Right , Bottom Right , Top Left , and Bottom Left .
Swap Main/Sub	Changes the main and sub screens.
Exit Picture in Picture	Exits the Picture in Picture display.

Operations and Settings Using the Network

When the projector is connected to a network, you can make settings and control the projector from a computer or smart device over the network.

Making Settings and Performing Operations from a Web Browser

When a computer or smart device with a Web browser is connected to the same network as the projector, you can change the projector's settings in the same way as operating a remote control.

Change settings using Web Control, and perform operations using Web Remote.

The following Web browsers are supported.

Windows: Internet Explorer 8, 9 and 10 (except for Metro)

Mac OS X: Safari



If you set **Standby Mode** to **Communication On**, you can use the Web browser to make settings and perform control even if the projector is in standby mode (when the power is off).  **Settings - Standby Mode** [p.73](#)

Changing the projector's settings (Web Control)

By using Web Control, you can change the projector's settings.



If your Web browser is set up to connect via a proxy server, the Web Control screen cannot be displayed. To display Web Control, you need to make settings so that a proxy server is not used for a connection.

Displaying the Web Control screen on your computer

- 1 Start the Web browser, and then enter the IP address of the projector in the address input box of the Web browser.

The Web Control screen is displayed.

When Web Control Password is set in the Network menu from the projector's Configuration menu, the password entry screen is displayed. Enter the text set in Web Control Password.  [p.77](#)



You can check the projector's IP address from the Configuration menu.  **Network - Net. Info. - Wired LAN** [p.77](#)

- 2 The user ID and password entry screen is displayed. Enter "EPSONWEB" as the user ID. The default password is "admin".

Displaying the Web Control screen on your smart device

- 1 Start the Web browser, and then enter the IP address of the projector in the address input box of the Web browser.

The **remote** and **config** icons are displayed in your Web browser.

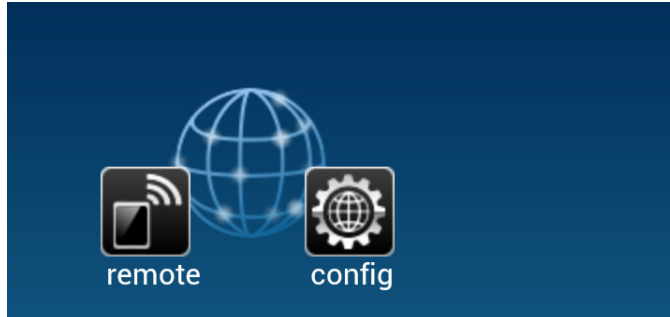

- 2 Tap the **config** icon.

The Web Control screen is displayed.

When Web Control Password is set in the Network menu from the projector's Configuration menu, the password entry screen is displayed. Enter the text set in Web Control Password.  [p.77](#)

- 3 The user ID and password entry screen is displayed. Enter "EPSONWEB" as the user ID.
The default password is "admin".

Items in the Configuration menu that cannot be set by Web Control

- **Settings - User Button**
- **Settings - Operation - High Altitude Mode**
- **Settings - Display - Menu Position**
- **Settings - Display - Menu Color**
- **Settings - Display - Standby Confirmation**
- **Settings - Panel Alignment**
- **Settings - Language**
- **Reset - Reset All**

The settings for items on each menu are the same as the projector's Configuration menu.  [p.68](#)

Operating the projector (Web Remote)

By using Web Remote, you can operate the projector from a Web browser.

Displaying the Web Remote screen on your computer

- 1 Display the Web Control screen.
 [p.63](#)

- 2 Click Web Remote.
The Web Remote screen is displayed.

Displaying the Web Remote screen on your smart device

- 1 Start the Web browser, and then enter the IP address of the projector in the address input box of the Web browser.



The **remote** and **config** icons are displayed in your Web browser.





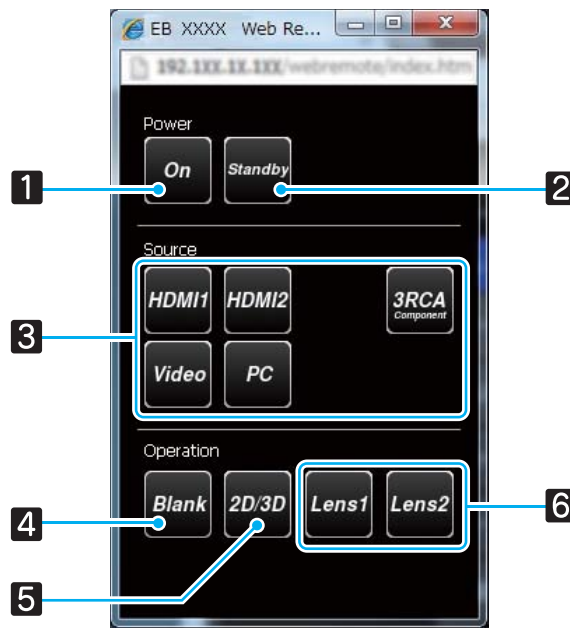





- 2 Tap the **remote** icon.
The Web Remote screen is displayed.

Web Remote screen buttons



	Button	Function
1		Turns the projector on. p.25
2		Turns the projector off. p.26

	Button	Function
3		Changes to the image from each input port.  p.32
4		Temporarily hides or shows the image.  p.34
5		Changes between 2D and 3D images.  p.37
6		Loads the lens position.  p.56

Using the Mail Notification Function to Report Problems

When you set Mail Notification in the Configuration menu, notification messages are sent to the preset email addresses when a problem or warning occurs with a projector. This will enable the operator to be notified of problems with projectors even at locations away from the projectors.  **Network - Mail - Mail Notification** [p.77](#)



- Up to a maximum of three notification destinations (addresses) can be registered, and notification messages can be sent to all three destinations at once.
- If a projector develops a critical problem and suddenly stops working, it may not be able to send a message notifying an operator of the problem.
- If you set **Standby Mode** to **Communication On**, you can monitor the projector even if it is in standby mode (when the power is off).  **Settings - Standby Mode** [p.73](#)

Reading error notification mail

When the Mail Notification function is set to On and a problem or warning occurs in the projector, the following email will be sent.

Subject: EPSON Projector

Line 1: The projector name where the problem has occurred

Line 2: The IP address set for the projector where the problem has occurred

Line 3 and on: Details of the problem

The details of the problem are listed line by line. The main message contents are listed below.

Message	Contents	Remedy
No-signal	No signal	No signal is input to the projector. Check the connection status or check that the power for the signal source is turned on.









Message	Contents	Remedy
Internal error	Internal error Laser driver error Fatal error Lens cover error	Handling errors or warnings is the same as checking the status of the indicators. ☛ p.83
Fan related error	Fan error	
Sensor error	Sensor error Light sensor error	
Cinema Filter Error	Cinema filter error	
Laser Error	Laser error Laser does not light up	
Internal temperature error	High temperature error	
High-speed cooling in progress	High temp warning	
Cinema Filter Warning	Cinema filter warning	
Static Iris Warning	Static iris warning	
Lens Iris Warning	Lens iris warning	
Static Iris Error	Static iris error	









Configuration Menu Functions

Configuration Menu Table

If there is no image signal being input, you cannot adjust items related to the image or signal in the Configuration menu. Note that the items displayed for the image, the signal, and other information vary depending on the image signal being projected.

Image menu

Function	Menu/Settings		Explanation
Color Mode	Dynamic, Bright Cinema, Natural, Cinema, Digital Cinema, Adobe RGB, 3D Dynamic, 3D Cinema		Select the image quality based on your surroundings and the image you are projecting.  p.42
Brightness			Adjusts the image brightness.
Contrast			Adjusts the contrast between light and shade in the images. By increasing the contrast, the images become vivid.
Color Saturation*1			Adjusts the color saturation for the images.
Tint*1			Adjusts the tint for the images.
Sharpness	Standard		Adjusts the sharpness for the whole image.
	Advanced*1	Thin Line Enhancement, Thick Line Enhancement, Vert. Line Enhancement, Horiz. Line Enhancement	 Adjusts the image sharpness. Use this to adjust specific areas.  p.50
Color Temp.	-3 - 6 (10 increments)*2		Adjusts the tint for the images. The image is tinted blue for high values, and tinted red for low values.
Skin Tone			Increase the number to make colors greener, and decrease the number to make colors redder.

Function	Menu/Settings		Explanation	
Advanced	Gamma	2, 1, 0, -1, -2	Performs gamma adjustments. You can select a raw value or adjust the gamma while looking at the image or graph.  p.47	
		Customized		Adjust it from the image, Adjust it from the graph
		Reset		
	RGB	Offset R/G/B		Adjusts the offset and gain for each R, G, and B color.  p.49
		Gain R/G/B		
RGBCMY	R/G/B/C/M/Y	Hue, Saturation, Brightness 	Adjusts the hue, saturation, and brightness for each R, G, B, C, M, and Y color.  p.47	
EPSON Super White*3	On, Off		(This can only be set when the Color Mode is set to Natural , Cinema , Adobe RGB , Digital Cinema , or 3D Cinema , and when receiving signal input from the HDMI1 or HDMI2 ports.) Set this to On if you are experiencing bright over exposure of whites in your image. When set to On , HDMI Video Range settings are disabled.	
Power Consumption	High, Medium, ECO		You can set the brightness to one of three settings. Select ECO if the images being projected are too bright. When ECO is selected, power consumption during projection decreases, and fan rotation noise is reduced.	
Dynamic Contrast	Off, Normal, High Speed		You can change the luminance adjustment tracking for changes in brightness in the displayed image. Set to Off for no luminance adjustment.  p.45	
Lens Iris			Adjusts the amount of light entering the lens with the lens diaphragm, which adjusts the contrast of the image.  p.51	
Reset	Yes, No		You can reset all adjustment values for Image to their default settings.	



*1 This is not displayed when a computer image signal is being input.

*2 When **Color Mode** is set to **Natural** or **Adobe RGB**, settings change to **5000K - 10000K**.

*3 Settings are saved for each type of input source or Color Mode.

■ Signal menu

Function	Menu/Settings		Explanation
3D Setup* ¹ * ²	3D Display	On, Off	Enables or disables the 3D image display function. 🖱️ p.37
	2D-to-3D Conversion	Off, Weak, Medium, Strong	Sets the strength of the 3D effect when converting 2D images to 3D images. 🖱️ p.40
	3D Format	Auto, Side by Side, Top and Bottom, 2D	Sets the 3D format for the input signal. When set to Auto , the format is recognized automatically.
	3D Depth	-10 to 10	Sets the depth for the 3D image.
	Diagonal Screen Size	60 to 300	Sets the projection size for the 3D image. By matching this to the actual size, you can achieve the optimum 3D effect.
	Inverse 3D Glasses	Yes, No	Reverses the synchronization timing for the left/right shutters on the 3D Glasses and the left/right images. Enable this function if the 3D effect is not displayed correctly.
	3D Viewing Notice	On, Off	Enables or disables the notification that appears when viewing 3D image content.
Aspect* ³	Auto, Normal, Full, Zoom, Anamorphic Wide, Horiz. Squeeze		Selects the aspect mode. 🖱️ p.32
Tracking* ³ * ⁴	Varies depending on the input signal.		Adjusts computer images when vertical stripes appear in the images.
Sync.* ³ * ⁴	0 to 31		Adjusts computer images when flickering, fuzziness, or interference appear in the images. <ul style="list-style-type: none"> • Adjusting the Brightness, Contrast, or Sharpness may cause flickering or blurriness. • Adjusting the synchronization after adjusting tracking allows for more accurate adjustments.
Position* ³ * ⁵			Adjusts the display position up, down, left, and right when a part of the image is missing so that the whole image is projected.
Deinterlacing* ³	Off, Video, Film/Auto* ⁶		(This can only be set when receiving signal input from the Video port or when receiving 480i, 576i, or 1080i signal input from the Component, HDMI1, or HDMI2 ports.) Converts the signal from interlaced (i) to progressive (p) using a method appropriate for the image signal. <ul style="list-style-type: none"> • Off: This is ideal for dynamic motion images. • Video: This is ideal for viewing general video images. • Film/Auto: Performs the optimal conversion for film, CG, or animation input signals.
Motion Detection* ³ * ⁶	1 to 5		Sets the image motion speed from 1 (slow, for still images) to 5 (fast, for movies). Change this setting if you are experiencing poor still image quality or flickering movies.

Function	Menu/Settings		Explanation
Frame Interpolation ^{*2 *6}	Off, Low, Normal, High		Reduces afterimages when projecting moving images by interpolating between one frame and the next.  p.46
Super-resolution/4K ^{*2 *6}	Off, 1, 2, 3, 4, 5, 4K-1, 4K-2, 4K-3, 4K-4, 4K-5		Super-resolution (1 to 5) reduces blurring that occurs at the edge of images when the image is increased to 1920 x 1080 pixels. 4K Enhancement (4K-1 to 4K-5) projects 4K images (3840 x 2160 pixels), employing super resolution processing and creating ultra high definition images.  p.43
Detail Enhancement ^{*2 *6 *7}	Range, Strength	0 to 100	Enhances details in an image to create clear outlines. The higher the number, the wider the range from the outline area effected by the enhancement.  p.45
Auto Setup ^{*4}	On, Off		Sets whether or not to automatically adjust the image whenever the input signal is changed. When enabled, the Tracking, Position, and Sync. are automatically configured.
Advanced	Noise Reduction ^{*2 *3 *6}	Off, 1, 2, 3	(This can only be set when Image Processing is set to Fine .) Smooths out rough images. There are three modes available. Select your favorite setting. It is recommended that this is set to Off when viewing image sources in which noise is very low, such as for DVDs or Blu-ray discs.
	Setup Level ^{*3 *6}	0%, 7.5%	(This can be set when receiving an NTSC or component video signal from the Video port.) Change this setting when using devices with a different black level (Setup Level) such as products designed for the Korean market. Check the specifications for your connected device before changing this setting.

Function	Menu/Settings		Explanation
(Advanced)	Overscan ^{*2 *3 *8}	Auto, Off, 2%, 4%, 6%, 8%	Changes the output image ratio (the range of the projected image). <ul style="list-style-type: none"> • Off, 2% to 8%: Sets the range of the image. Off projects all ranges. Depending on the image signal you may notice noise at the top and bottom of the image. • Auto: This can only be set when receiving signal input from the HDMI1 or HDMI2 ports. This may be automatically set to Off or 8% depending on the input signal.
	HDMI Video Range ^{*1 *3}	Auto, Normal, Expanded	(This can only be set when EPSON Super White is set to Off .) When set to Auto , the video level for the DVD input signal to the HDMI1 or HDMI2 ports is automatically detected and set. If you experience under or overexposure when set to Auto , set the video level of the projector to match that of the DVD/Blu-ray disc player's video level. Your DVD/Blu-ray disc player may be set to Normal or Expand. The Auto option is not displayed when connected to a connected device's DVI port.
	Color Space ^{*1}	Auto, BT.709, BT.2020	Sets the conversion system for the color space.
	Dynamic Range ^{*1}	Auto, SDR, HDR Mode1, HDR Mode2, HDR Mode3, HDR Mode4	When receiving an HDR (High Dynamic Range) signal, use this when HDR information is not displayed correctly in the image signal. (HDMI1 port only)
	EDID	EDID1, EDID2	Disconnect the cable from the projector's HDMI port, and then make settings. Select EDID2 when not projecting in HDR mode.
	Image Processing ^{*6}	Fine, Fast	Performs processing to improve the image quality or response speed.  p.52
Reset	Yes, No		Resets all Signal settings except for Diagonal Screen Size , 3D Viewing Notice , Aspect , and Image Processing settings to their default settings.

*1 Only displayed when an HDMI1 or HDMI2 image signal is being input.

*2 This cannot be set when a 4K image signal is being input.

*3 Settings are saved for each type of input source or signal.

*4 This is only displayed when a PC image signal is being input.









*5 This cannot be set when an HDMI1 or HDMI2 image signal is being input.



*6 This is not displayed when a PC image signal is being input.







*7 Settings are saved for each setting in Source, Color Mode, or Super-resolution/4K.



*8 Only displayed when a Component, HDMI1, or HDMI2 image signal is being input.

Settings menu

Function	Menu/Settings		Explanation
Keystone	-60 to 60		Performs vertical keystone correction.  p.31
HDMI Link	Device Connections	-	Displays a list of devices connected to the HDMI1 or HDMI2 ports.
	HDMI Link	On, Off	Enables or disables the HDMI Link function.
	Power On Link	Off, Bidirectional, Device -> PJ, PJ -> Device	Sets the link function when the power is turned on. Set to power on the projector when content is played on a connected device (Bidirectional or Device -> PJ) or to power on a connected device when the projector is turned on (Bidirectional or PJ -> Device).
	Power Off Link	On, Off	Sets whether or not to power off connected devices when the projector is turned off.
Lock Setting	Lens Lock	On, Off	When set to On , the focus, zoom, and lens shift settings are locked at their current settings. If you press the  button when Lens Lock is set to On ,  is displayed on the screen.
	Child Lock	On, Off	This locks the  button on the projector's control panel to prevent children from turning on the projector by accident. You can turn on the power when locked by holding down the  button for approximately three seconds. You can still turn off the device using the  button, or perform operations with the remote control as usual. If changed, this setting is enabled after you power off the projector and the cool-down process is complete. Note that even if Child Lock is set to On , the projector still turns on when the power cord is connected if Direct Power On is set to On .
	Control Panel Lock	On, Off	When set to On , all buttons on the control panel except for the  button are disabled.  is displayed on the screen if any buttons are pressed. To unlock, press and hold the  button on the control panel for at least 7 seconds. If changed, this setting is enabled once you close the Configuration menu.

Function	Menu/Settings	Explanation
Projection	Front, Front/Ceiling, Rear, Rear/Ceiling	<p>Change this setting depending on how the projector is installed.</p> <ul style="list-style-type: none"> • Front: Select if you are projecting in front of the screen. • Front/Ceiling: Select if you are projecting in front of the screen suspended from the ceiling. • Rear: Select if you are projecting to a rear screen from the back. • Rear/Ceiling: Select if you are projecting to a rear screen from the back when the projector is suspended from the ceiling.
User Button	2D-to-3D Conversion, 3D Depth, Inverse 3D Glasses, Power Consumption, Detail Enhancement, Info	<p>Select a Configuration menu item to assign to the  button on the remote control. By pressing the  button, the assigned menu item selection/adjustment screen is displayed, allowing you to make one-touch settings/adjustments.</p>
Picture in Picture*	-	<p>Starts the Picture in Picture display.  p.61</p>
Standby Mode	Communication On, Communication Off	<p>When set to Communication On, you can make settings and control the projector over the network even when the projector is in standby status.</p>









Function	Menu/Settings		Explanation
Operation	Direct Power On	On, Off	You can set up the projector so that projection starts as soon as the power cord is plugged in without any button operations. Note that when this is set to On , projection starts if power is restored after a blackout or other power outage and the power cord is still plugged into the projector.
	Sleep Mode	Off, 5min., 10min., 20min.	If the set time is exceeded and no signal is input, the projector is automatically turned off and enters standby mode. When set to Off , the projector never enters sleep mode. When in standby mode, press the  button on the remote control or the  button on the control panel to start projection.
	Illumination	On, Off	Set this to Off if the light from the indicators on the control panel bothers you when watching a movie in a dark room.
	Trigger Out 1 Trigger Out 2	Off, Power, Anamorphic Wide	Set the Trigger Out function to communicate the projector's power on status to external devices. Trigger Out 1 corresponds to the Trigger out 1 port, and Trigger Out 2 corresponds to the Trigger out 2 port. When set to Off , no voltage is output from the Trigger out 1/Trigger out 2 ports. When set to Power , voltage is output from the Trigger out 1/Trigger out 2 ports when the projector is on. For Anamorphic Wide , when the projector is on and Aspect is set to Anamorphic Wide or Horiz. Squeeze , voltage is output from the Trigger out 1/Trigger out 2 ports. If you change this setting, the new setting will take effect the next time you turn the projector on.
	High Altitude Mode	On, Off	Set this to On if you are using the projector above an altitude of 1500 meters.
	Lens Adjustment Mode	1, 2, 3	Set the amount of lens movement for the focus, zoom, and lens shift adjustments when pressing the     buttons once. The default value is 2 . Select 1 to make the amount of movement smaller, and select 3 to make the amount of movement larger.

Function	Menu/Settings		Explanation
Display	Menu Position	-	Sets the position where the menu should be displayed.
	Menu Color	Color 1, Color 2	<p>Selects the color for the Configuration menu.</p> <ul style="list-style-type: none"> • Color 1 Top menu: Black Selected items: Gray • Color 2 Top menu: Blue Selected items: Orange
	Messages	On, Off	<p>Sets whether or not to display the following messages (On or Off).</p> <ul style="list-style-type: none"> • Item names for image signals, color modes, aspect ratios, and loading memory. • If the internal temperature is rising when no image signal is being input or an unsupported signal is detected.
	Display Background	Black, Blue, Logo	Selects the screen status when no image signal is being input.
	Startup Screen	On, Off	Sets whether or not to show a startup screen when projection begins (On or Off). If changed, this setting is enabled after you power off the projector and the cool-down process is complete.
	Standby Confirmation	On, Off	Sets whether or not to display a standby confirmation message (On or Off).  p.26
	Model Name	On, Off	Displays the projector's model name.
Input Signal	Video Signal	Auto, NTSC, NTSC4.43, PAL, M-PAL, N-PAL, PAL60, SECAM	<p>Sets the signal type depending on the video device connected to the Video port. When set to Auto, the video signal is set automatically. If you notice noise in the image even when set to Auto, or if you are not seeing any image at all, select the correct signal type from the available options.</p>
	Component	Auto, YCbCr, YPbPr	<p>Sets the output signal for the video device connected to the Component ports. When set to Auto, the output signal is set automatically. If you notice unnatural colors when set to Auto, set the appropriate output signal from the available options.</p>
Panel Alignment	Panel Alignment	On, Off	Enables or disables Panel Alignment .
	Select Color	R, B	Select the color to correct.
	Pattern Color	R/G/B, R/G, G/B	Select the pattern used for correction.
	Start Adjustments	-	Starts Panel Alignment .  p.51
	Reset	Yes, No	Resets the correction value.
Language	-		Selects the display language.

Function	Menu/Settings	Explanation
Reset	Yes, No	<p>All adjustment values for Settings are returned to their default settings, except for the following.</p> <ul style="list-style-type: none"> • Power On Link • Power Off Link • Projection • User Button • Standby Mode • High Altitude Mode • Component • Language

* Cannot be set when a 4K image signal is being input.





Memory menu

Function	Explanation
Load Memory	Loads settings saved using the Save Memory function.  p.59 This cannot be selected if you have not saved any settings with the Save Memory function.
Save Memory	Saves certain Image menu and Signal menu settings to memory.  p.58
Erase Memory	Erases the saved memory.  p.59
Rename Memory	Renames a saved memory.  p.59
Load Lens Position	Loads adjustment values saved using the Save Lens Position function.  p.56 This cannot be selected if you have not saved any settings with the Save Lens Position function.
Save Lens Position	Saves the focus, zoom, and lens shift adjustment as a lens position.  p.56
Erase Lens Position	Erases the saved lens position.  p.57
Rename Lens Position	Renames a saved lens position.  p.57

Network menu

When you have made network settings for the projector and you connect to a computer or smart device on the network, you can change settings from your Web browser without displaying the Configuration menu, or you can use the computer or smart device as a remote control.

Also, when mail notification settings have been made and an error or warning occurs in the projector, a notification email is sent to the email addresses you have specified.

Function	Explanation
Net. Info. - Wired LAN	<p>Displays the following network setting status information.</p> <ul style="list-style-type: none"> • Projector Name • DHCP • IP Address • Subnet Mask • Gateway Address • MAC Address
Network Configuration	<p>The following menus are available for setting Network items.</p> <ul style="list-style-type: none"> • Basic  p.78 • Wired LAN  p.79 • Mail  p.79 • Others  p.80 • Reset  p.80

Network menu operations

Selecting from the top menu and sub menus, and changing selected items is the same as making operations from the Configuration menu. When done, make sure you go to the **Complete** menu, and select **Yes**, **No**, or **Cancel**. When you select **Yes** or **No**, you are returned to the Configuration menu.

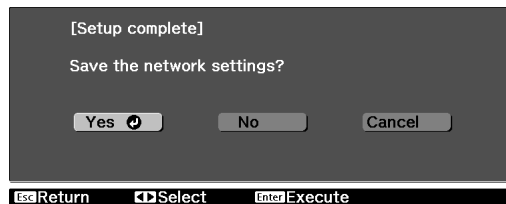

Yes: Saves the settings and exits the **Network** menu.

No: Does not save the settings and exits the **Network** menu.

Cancel: Allows you to continue making settings without exiting the **Network** menu.

Basic menu

Function	Explanation
Projector Name	<p>The name used to identify this projector on a network. When editing, you can enter up to 16 single-byte alphanumeric characters. (" * + , / ; < = > ? [¥] ` cannot be used.)</p>
PJLink Password	<p>Set a password to use when you access the projector using compatible PJLink software. You can enter up to 32 single-byte alphanumeric characters. (Symbols cannot be used.)</p>
Web Control Password	<p>Set a password to use Web Control. You can enter up to 8 single-byte alphanumeric characters. (* cannot be used.) Web Control is a function that allows you to change the projector's settings by using the Web browser on a computer or smart device connected to the network.  p.63</p>

Wired LAN menu

Function	Menu/Settings		Explanation
IP Settings	DHCP	On, Off	Set whether or not (On/Off) to use DHCP. If this is set to On , you cannot set any more addresses.
	IP Address		Enter the IP address assigned to the projector. You can enter a number from 0 to 255 in each field of the address. However, the following IP addresses cannot be used. 0.0.0.0, 127.x.x.x, 224.0.0.0 to 255.255.255.255 (where x is a number from 0 to 255)
	Subnet Mask		Enter the projector's subnet mask. You can enter a number from 0 to 255 in each field of the address. However, the following subnet masks cannot be used. 0.0.0.0, 255.255.255.255
	Gateway Address		Enter the projector's gateway IP address. You can enter a number from 0 to 255 in each field of the address. However, the following gateway addresses cannot be used. 0.0.0.0, 127.x.x.x, 224.0.0.0 to 255.255.255.255 (where x is a number from 0 to 255)
IP Address Display	On, Off		Set to Off to prevent the IP address from being displayed on the Net. Info. - Wired LAN or Web Control screen.

Mail menu

When this is set, you receive an email notification if a problem or warning occurs in the projector.

Function	Menu/Settings		Explanation
Mail Notification	On, Off		Set to On to send an email to the preset addresses when a problem or warning occurs with a projector.
SMTP Server	-		Enter the IP address for the SMTP server for the projector. You can enter a number from 0 to 255 in each field of the address. However, the following IP addresses cannot be used. 127.x.x.x, 224.0.0.0 to 255.255.255.255 (where x is a number from 0 to 255)
Port Number	1 to 65535		Enter the port number for the SMTP server. The default value is 25. You can input numbers between 1 to 65535.

Function	Menu/Settings	Explanation
Address 1 Setting Address 2 Setting Address 3 Setting	-	Enter the destination email addresses to which to send the notification email, and select the problems or warnings you want to be notified about. You can register up to three destinations. You can enter up to 64 single-byte alphanumeric characters for the email addresses. (" () , ; < > [¥] cannot be used.) You can enter up to 32 characters on the Configuration menu. When entering more than 32 characters, use your Web browser to enter the text. 🖱️ p.63

Others menu

Function	Menu/Settings	Explanation
AMX Device Discovery	On, Off	When you want to allow the projector to be detected by AMX Device Discovery, set this to On . Set this to Off if you are not connected to an environment controlled by a controller from AMX or AMX Device Discovery.
Control4 SDDP	On, Off	When you want to allow the projector to be detected by Control4 SDDP, set this to On . Set this to Off if the projector is not connected to an environment controlled by a controller from Control4 or Control4 SDDP.
Bonjour	On, Off	Set this to On when connecting to the network using Bonjour. See Apple's Web site for more information on the Bonjour service. http://www.apple.com/





Reset menu

To reset all of the network settings, select **Yes**. After you reset all the settings, the **Basic** menu appears.



Complete menu

Select this when you have finished making settings on the **Network** menu. 🖱️ p.78

Soft keyboard operations

The **Network** menu contains items that require input of alphanumerics during setup. In this case, the following soft keyboard is displayed. Use the     buttons to move the cursor to the desired key, and then press the  button to enter the selected character. After inputting, press **Finish** on the soft keyboard to confirm your input. Press **Cancel** on the soft keyboard to cancel your input.



- Each time the **CAPS** key is selected and the  button is pressed, it sets and changes between upper case and lower case letters.
- Each time the **SYM1/SYM2** key is selected and the  button is pressed, it sets and changes the symbol keys for the section enclosed by the frame.

The following types of character can be entered.

Numbers	0123456789
Letters	ABCDEFGHIJKLMNOPQRSTUVWXYZabcdefghijklmnopqrstuvwxyz
Symbols	! # \$ % & ' () + - . / < = > ? @ ` ^ _ { } ~



- You cannot use colons (:) for **Network** menu items.
- You cannot use spaces for **Network** menu items.
- The following four characters cannot be entered using the soft keyboard. Enter these characters using a Web browser.  [p.63](#)
" * , ;

Info menu

Function	Explanation
Operation Hours	Displays the total usage time.
Source	Displays the source name for the connected equipment currently being projected.
Input Signal	Displays the content of Input Signal set in the Signal menu according to the source.
Resolution	Displays the resolution.
Scan Mode	Displays the scan mode.
Refresh Rate	Displays the refresh rate.
3D Format	Displays the 3D format of the signal input during 3D projection (Frame Packing, Side by Side, or Top and Bottom).
Sync Info	Displays the image signal information. This information may be needed if service is required.
Color Depth	Displays the color depth.
Color Format	Displays information on the color space and dynamic range.
Video Signal	Displays the settings for Video Signal in the Settings menu.
Status	This is information about errors that have occurred on the projector. This information may be needed if service is required.
Serial Number	Displays the projector's serial number.
Version	Displays the firmware version of the projector.

Reset menu





Function	Explanation
Reset All	Resets all items in the Configuration menu to their default settings. The following items are not reset to their defaults: Input Signal - Component, Panel Alignment, Language, Save Memory, Save Lens Position, and Operation Hours.
Reset Memory	Erases all settings saved using the Save Memory function.
Reset Lens Position	Erases all settings saved using the Save Lens Position function.

Picture in Picture menu

Displayed by pressing the  button during Picture in Picture projection.





This cannot be set when 3D image or 4K image signals are being input.

Function	Menu/Settings		Explanation
Picture in Picture	Subscreen Size	Small, Large	Changes the size of the sub screen.  p.62
	Subscreen Position	Top Right, Bottom Right, Top Left, Bottom Left	Changes the position of the sub screen.  p.62
	Swap Main/Sub		Changes the main and sub screens.  p.62
	Exit Picture in Picture		Exits the Picture in Picture display.  p.62

Problem Solving



Reading the Indicators

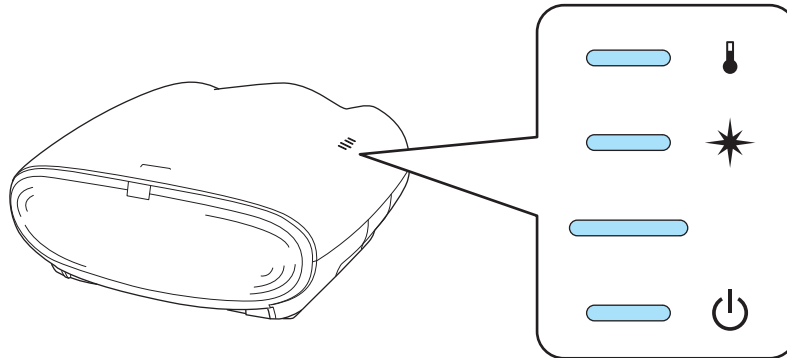















You can check the status of the projector from the flashing and lit , ,  operation indicators.



Refer to the following table to check the projector's status and how to remedy problems shown by the indicators.

Indicator status during an error/warning









 : Lit  : Flashing  : Status maintained  : Off

Indicators	Status	Remedy
       (blue)/(orange)	High temp warning	You can continue projecting. If the temperature rises too high again, projection stops automatically. <ul style="list-style-type: none"> • If the projector is installed next to a wall, make sure there is at least 20 cm between the wall and the projector's air intake vent. • If the air filter is clogged, clean it.  p.94
       (blue)/(orange)	High temp error (overheating)	The internal temperature is too high. <ul style="list-style-type: none"> • The laser turns off automatically and projection stops. When the fan has stopped, disconnect the power cord. • If the projector is installed next to a wall, make sure there is at least 20 cm between the wall and the projector's air intake vent. • If the air filter is clogged, clean it.  p.94 • If turning the power back on does not clear the problem, stop using the projector and remove the power plug from the electrical outlet. Contact your local dealer or the nearest Epson repair center.  Epson Projector Contact List

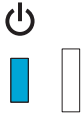

Indicators	Status	Remedy
<p>(blue)/(orange)</p>	Internal error	<p>The projector has malfunctioned. Remove the power plug from the electrical outlet, and contact your local dealer or the nearest Epson repair center. Epson Projector Contact List</p>
<p>(blue)/(orange)</p>	Fan error Sensor error Light sensor error	
<p>(blue)/(orange)</p>	Cinema filter error Static iris error Lens cover error	
<p>(blue)/(orange)</p>	Laser driver error	
<p>(blue)/(orange)</p>	Fatal error	
<p>(blue)/(orange)</p>	Laser error Laser light failure	<p>There is a problem with the laser section, or it failed to turn on.</p> <ul style="list-style-type: none"> When using at an altitude of 1500 m or more, set High Altitude Mode to On. Settings - Operation - High Altitude Mode p.73 If the problem does not improve even after trying the solutions mentioned above, stop using the projector and remove the power plug from the electrical outlet. Contact your local dealer or the nearest Epson repair center. Epson Projector Contact List

Indicator status during normal operation

: Lit : Flashing : Off

Indicators	Status	Remedy
	Standby condition	When you press the  button on the remote control, or the  button on the control panel, projection starts.
 (blue)	Standby condition (Standby Mode is set to Communication On.)	When you press the  button on the remote control, or the  button on the control panel, projection starts.
 (blue)	Warm-up in progress Cool-down in progress	The power-off operation is disabled while the projector is warming-up. All operations are disabled while the projector is cooling-down. The projector enters standby condition when cool-down is complete. If for any reason the power cord is disconnected during cool-down, wait until the projector has cooled down sufficiently, reconnect the power cord, and then press the  button on the remote control, or the  button on the control panel.
 (blue)	Projection in progress	The projector is operating normally.



- Under normal operating conditions, the  and  indicators are off.
- When the **Illumination** function is set to **Off**, all indicators are off under normal projection conditions.
 **Settings - Operation - Illumination** [p.73](#)

When the Indicators Provide No Help

Check the problem



Check the following table to see if your problem is mentioned, and go to the appropriate page for information on handling the problem.

Problem		Page
Problems relating to images	No images appear Projection does not start, the projection area is completely black, or the projection area is completely blue	p.86
	Moving images being projected from a computer are not projected	p.87
	" Not supported " is displayed	p.87
	" No Signal " is displayed	p.88
	Images are fuzzy or out of focus	p.88
	Interference or distortion appears in the images	p.88
	The image is truncated (large) or small, or only a part of the image is projected	p.89
	Image colors are not right The whole image appears purplish or greenish, images are black & white, or colors appear dull*	p.89
	Images appear dark	p.90
	Projection stops automatically	p.90
	The LCD Alignment correction is not satisfactory or difficult to achieve	p.90
Problems when projection starts	The projector does not turn on	p.91
Problems with the remote control	The remote control does not respond	p.91
Problems with the control panel	Cannot make settings on the control panel	p.91
Problems with 3D images	Cannot project correctly in 3D	p.92
	The 3D image is enlarged and truncated	p.92
Problems with HDMI	HDMI Link does not function	p.92
	The device name is not displayed under Device Connections	p.93

* Because color reproduction differs between monitors and computer LCD screens, the image projected by the projector and the color tones displayed on the monitor may not match, however this is not a fault.

■ Problems relating to images

No images appear

Check	Remedy
Is the power turned on?	Press the  button on the remote control or the  button on the control panel.
Is the power cord connected?	Connect the power cord.
Are the indicators switched off?	Disconnect and then reconnect the projector's power cord. Check that pressing the power button after connection supplies the projector with power.
Is an image signal being input?	Check that the connected device is turned on. When Messages is set to On from the Configuration menu, image signal messages are displayed.  Settings - Display - Messages p.73

Check	Remedy
Has the power to the AV amplifier been disconnected?	If an AV amplifier is connected, check the AV amplifier's power supply.
Is an image signal being sent from the device?	Check that an image signal is being sent from the connected device.
Is the image signal format setting correct?	When Video is input If nothing is projected even when Video Signal is set to Auto from the Configuration menu, set the signal that matches the connected device. 🖱️ Settings - Input Signal - Video Signal p.73
	When Component is input If nothing is projected even when Component is set to Auto from the Configuration menu, set the signal that matches the connected device. 🖱️ Settings - Input Signal - Component p.73
Are the Configuration menu settings correct?	Reset all of the settings. 🖱️ Reset - Reset All p.82
(Only when projecting computer image signals) Was the connection made while the power of the projector or the computer was already turned on?	If the connection is made while the power is already turned on, the key (Function key and so on) that changes the computer's image signal to external output may not work. Turn off the connected computer, and then turn it back on.



Moving images are not displayed

Check	Remedy
(Only when projecting computer image signals) Is the computer's image signal set to external output and to output to the LCD monitor at the same time?	Depending on the computer's specifications, moving images may not be displayed when the computer is set to external output and to the LCD monitor output at the same time. Change it so that the image signal is set to external output only. For the computer's specifications, see the documentation supplied with the computer.



"Not supported" is displayed

Check	Remedy
Is the image signal format setting correct?	When Video is input If nothing is projected even when Video Signal is set to Auto from the Configuration menu, set the signal that matches the connected device. 🖱️ Settings - Input Signal - Video Signal p.73
	When Component is input If nothing is projected even when Component is set to Auto from the Configuration menu, set the signal that matches the connected device. 🖱️ Settings - Input Signal - Component p.73
(Only when projecting computer image signals) Do the image signal's frequency and resolution correspond to the mode?	Check the image signal being input in Resolution from the Configuration menu, and check that it corresponds to the projector's resolution. 🖱️ p.98



"No Signal" is displayed



Check	Remedy
Are the cables connected correctly?	Check that all the cables required for projection are securely connected.  p.20
Is the correct image input port selected?	Change the image with the source buttons on the remote control, or the <input type="button" value="Source"/> button on the control panel.  p.32
Is the connected device turned on?	Turn on the device.
(Only when projecting computer image signals) Are the image signals being output to the projector?	Change it so that the image signal is set to external output, and not just the computer's LCD monitor. For some models, when the image signals are output externally, they no longer appear on the LCD monitor. For the computer's specifications, see the documentation supplied with the computer. If the connection is made while the power of the projector or the computer is already turned on, the Fn key (Function key) that changes the computer's image signal to external output may not work. Turn off the computer and the projector, and then turn them back on.

Images are fuzzy or out of focus

Check	Remedy
Has the focus been adjusted?	Adjust the focus.  p.30
Is the projector at the correct distance?	Check the recommended projection range.  p.17
Has condensation formed on the lens?	If the projector is suddenly taken from a cold environment to a warm environment, or if sudden ambient temperature changes occur, condensation may form on the surface of the lens, and this may cause the images to appear fuzzy. Set the projector up in the room about one hour before it is used. If the projector is wet from condensation, turn off the projector, disconnect the power cord, and leave it for a while.

Interference or distortion appear in images

Check	Remedy
Is the image signal format setting correct?	When Video is input If nothing is projected even when Video Signal is set to Auto from the Configuration menu, set the signal that matches the connected device.  Settings - Input Signal - Video Signal p.73
	When Component is input If nothing is projected even when Component is set to Auto from the Configuration menu, set the signal that matches the connected device.  Settings - Input Signal - Component p.73
Are the cables connected correctly?	Check that all the cables required for projection are securely connected.  p.20

Check	Remedy
Is an extension cable being used?	If an extension cable is used, electrical interference may affect the signals.
(Only when projecting computer image signals) Are the Sync. and Tracking settings adjusted correctly?	The projector uses automatic adjustment functions to project at the optimum status. However, depending on the signal, some may not be adjusted correctly even after performing self corrections. If this happens, adjust the Tracking and Sync. settings from the Configuration menu.  Signal - Tracking/Sync. p.70
(Only when projecting computer image signals) Is the correct resolution selected?	Set the computer so that the signals being output are compatible with the projector.  p.98

Part of the image is truncated (large) or small











Check	Remedy
Is the correct Aspect selected?	Press the <input type="button" value="Aspect"/> button, and then select the Aspect that matches the input signal.  Signal - Aspect p.70
(Only when projecting computer image signals) Is the correct resolution selected?	Set the computer so that the signals being output are compatible with the projector.  p.98

Image colors are not right

Check	Remedy
Is the image signal format setting correct?	When Video is input If nothing is projected even when Video Signal is set to Auto from the Configuration menu, set the signal that matches the connected device.  Settings - Input Signal - Video Signal p.73 When Component is input If nothing is projected even when Component is set to Auto from the Configuration menu, set the signal that matches the connected device.  Settings - Input Signal - Component p.73
Are the cables connected correctly?	Check that all the cables required for projection are securely connected.  p.20 For the Video and Component ports, make sure the connector is the same color as the cable port.  p.20
Is the contrast adjusted correctly?	Adjust the Contrast setting from the Configuration menu.  Image - Contrast p.68
Is the color adjusted correctly?	Adjust the Advanced setting from the Configuration menu.  Image - Advanced p.68
(Only when projecting images from a video device) Are the color saturation and tint adjusted correctly?	Adjust the Color Saturation and Tint settings from the Configuration menu.  Image - Color Saturation/Tint p.68



Images appear dark

Check	Remedy
Is the image brightness set correctly?	Adjust the Brightness setting from the Configuration menu.  Image - Brightness p.68
Is the contrast adjusted correctly?	Adjust the Contrast setting from the Configuration menu.  Image - Contrast p.68



Images are rough (when connected to the HDMI1 port)

Check	Remedy
Has EDID been set?	Remove the HDMI cable, and then make EDID settings.

Projection stops automatically





Check	Remedy
Is Sleep Mode enabled?	If the set time is exceeded and no signal is input, the laser turns off automatically, and the projector enters standby status. The projector returns from standby status when you press the  button on the remote control or the  button on the control panel. Do not look into the laser when returning from standby status. If you do not want to use Sleep Mode , change the setting to Off .  Settings - Operation - Sleep Mode p.73

The Panel Alignment adjustment is not satisfactory or difficult to achieve

Check	Remedy
Does the Projection setting match the projector's installation position?	The panel alignment adjustment method changes depending on the Projection setting. Make sure the Projection setting matches the projector's installation position.  Settings - Projection p.73
Is the projection surface suitable?	For best results, the projection surface should not be colored or textured, otherwise the adjustment grids will be difficult to align. Project onto a screen and so on that is white and does not have a pattern.
Were adjustments made immediately after the projector was turned on?	To obtain stable image quality, leave the projector on for a while before making adjustments.
Is the image size suitable?	The projected image should be a minimum of 60".
Is the shifted color magenta?	Adjust R (red) and B (blue) for Select Color since magenta is a mixture of red and blue.
Do the lines in the pattern look fuzzy or out of focus?	Adjust the focus.  p.30



■ Problems when projection starts

The projector does not turn on

Check	Remedy
Is the power turned on?	Press the  button on the remote control or the  button on the control panel.
Is Child Lock set to On ?	When Child Lock is set to On from the Configuration menu, hold down the  button on the control panel for approximately three seconds, or perform operations from the remote control.  Settings - Lock Setting - Child Lock p.73
Do the indicators turn on and off when the power cord is touched?	Turn off the projector, and then disconnect and reconnect the projector's power cord. If the problem continues, stop using the projector, remove the power plug from the electrical outlet, and contact your local dealer or the nearest projector information center.  Epson Projector Contact List



■ Problems with the remote control

The remote control does not respond

Check	Remedy
Is the remote control light-emitting area pointing towards the remote receiver on the projector during operation?	Point the remote control towards the remote receiver. Also, check the operating range.  p.24
Is the remote control too far from the projector?	Check the operating range.  p.24
Is direct sunlight or strong light from fluorescent lamps shining onto the remote receiver?	Set the projector up in a location where strong light does not shine onto the remote receiver.
Are the batteries dead or have the batteries been inserted correctly?	Make sure the batteries are inserted correctly or replace the batteries with new ones if necessary.  p.24

■ Problems with the control panel

Cannot make settings on the control panel

Check	Remedy
Is Control Panel Lock set to On ?	If Control Panel Lock is set to On from the Configuration menu, all of the control panel buttons except for the  button are disabled. Perform operations from the remote control.  Settings - Lock Setting - Control Panel Lock p.73

■ Problems with 3D images

Cannot project correctly in 3D

Check	Remedy
Are the 3D Glasses turned on?	Turn on the 3D Glasses.
Is a 3D image being projected?	If the projector is projecting a 2D image, or if an error occurs on the projector that prevents the 3D image from being projected, you cannot view 3D images even if you are wearing the 3D Glasses.
Is the input image in 3D?	Check that the input image is 3D compatible. Since most TV broadcasts do not contain a 3D format signal, 3D reception must be set manually.
Is 3D Display set to Off ?	If 3D Display is set to Off from the Configuration menu, the projector does not automatically change to 3D even when a 3D image is input. Press the  button. 🖱️ Signal - 3D Setup - 3D Display p.70
Is the correct 3D format set?	The projector automatically selects the appropriate 3D format, but if the 3D image is not displayed correctly, use 3D Format from the Configuration menu to select another format. 🖱️ Signal - 3D Setup - 3D Format p.70
Are you viewing within the reception range?	Check the range within which the 3D Glasses can communicate with the projector, and view within that range. 🖱️ p.39
Has pairing been performed correctly?	See the User's Guide for the 3D Glasses to perform pairing.
Are there any devices that cause radio wave interference in the vicinity?	When using other devices at the same time with the frequency band (2.4 GHz) such as Bluetooth communication devices, wireless LAN (IEEE802.11b/g), or microwave ovens, radio wave interference may occur, the image may be interrupted, or communication may not be possible. Do not use the projector near these devices.



The 3D image is enlarged and truncated

Check	Remedy
Is the correct 3D video format set?	Video may be truncated if an incorrect 3D format is set. Set the correct 3D format. 🖱️ p.35

■ Problems with HDMI

HDMI Link does not function

Check	Remedy
Are you using a cable that meets the HDMI standards?	Only high-speed HDMI cables are supported.

Check	Remedy
Does the connected device meet the HDMI CEC standards?	If the connected device does not meet the HDMI CEC standards, it cannot be operated even if it is connected to the HDMI port. See the documentation and so on supplied with the connected device for more information. Also, press the  button, and then check if the device is available under Device Connections .  p.54
Are the cables connected correctly?	Check that all the cables required to use HDMI Link are securely connected.  p.54
Is the power for the amplifier or DVD/Blu-ray disc player and so on turned on?	Put each device in standby status. See the documentation and so on supplied with the connected device for more information.
Was a new device connected, or was the connection changed?	If the CEC function for a connected device needs to be set again, for example when a new device is connected or the connection is changed, you may need to restart the device.
Are many multi-media players connected?	Up to 3 multi-media players that meet the HDMI CEC standards can be connected at the same time.

The device name is not displayed under Device Connections

Check	Remedy
Does the connected device meet the HDMI CEC standards?	If the connected device does not meet the HDMI CEC standards, it is not displayed. See the documentation and so on supplied with the connected device for more information.



Maintenance

Cleaning the Parts

You should clean the projector if it becomes dirty or if the quality of projected images starts to deteriorate.

Warning

Do not use sprays that contain flammable gas to remove dirt and dust from the projector's air filter, and so on. The gases may ignite and result in fire.

Cleaning and replacing the air filter

Clean the air filter if dust has accumulated on the air filter or when the following message is displayed. **"The projector is overheating. Make sure nothing is blocking the air vent, and clean or replace the air filter."**

Attention

- If dust collects on the air filter, it can cause the internal temperature of the projector to rise, and this can lead to problems with operation and shorten the optical engine's service life. It is recommended that you clean the air filter periodically. Clean more frequently if you are using the projector in a particularly dusty environment.
- Do not rinse the air filter in water. Do not use detergents or solvents.
- Lightly brush the air filter to clean it. If it is brushed too strongly, dust will be ground into the air filter and cannot be removed.



Dispose of used air filters properly in accordance with your local regulations.
Material: PP

1 Press the  button on the remote control or the control panel to turn off the power, and then disconnect the power cord.

2 Remove the cable cover if it is attached.  [p.20](#)

3 Open the air filter cover.
Hook your finger into the tab on the air filter cover, and pull it to swing it open.

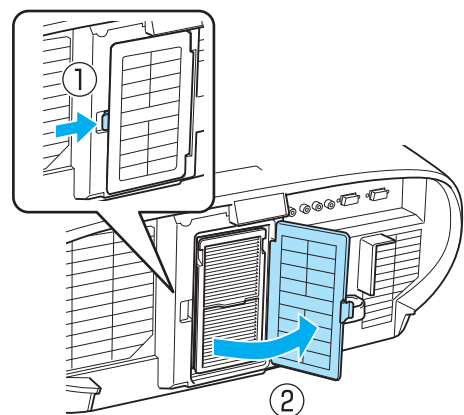

- 4** Remove the air filter.
Grip the knob in the center of the air filter and pull it out at an angle.

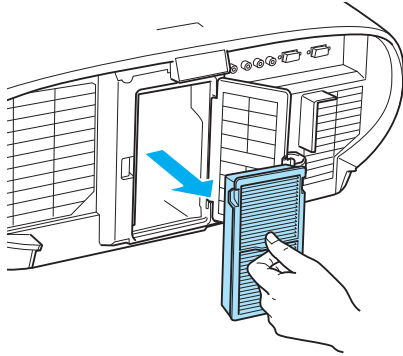

- 5** Hold the air filter with the surface facing down and tap it 4 or 5 times to remove the dust.

Turn it over and tap the other side in the same way.

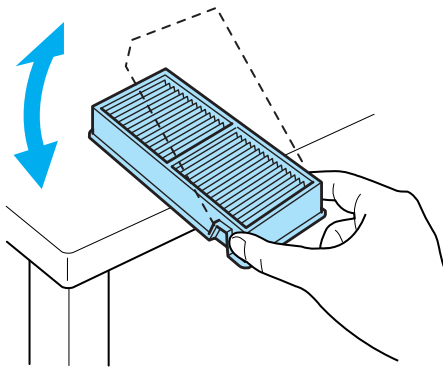

Attention

If the air filter is hit too hard, it may become unusable due to deformities and cracks.

- 6** Remove any dust remaining on the air filter by using a vacuum cleaner from the front side.

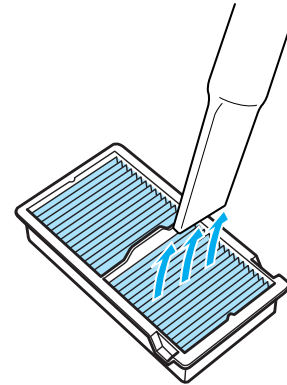

Replace the air filter if a message is displayed even after cleaning the air filter, or if it is still soiled.
p.97

- 7** Install the air filter.
Grip the air filter by the knob in the center and insert it at an angle.

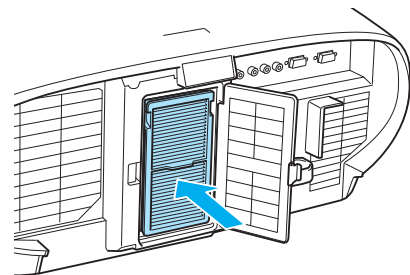

- 8** Close the air filter cover.
Press until the tab on the air filter cover clicks into place.

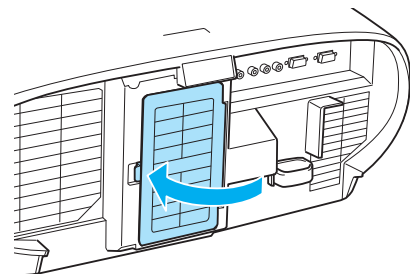

Cleaning the main unit

Clean the projector's surface by wiping it gently with a soft cloth.

If it is particularly dirty, moisten the cloth with water containing a small amount of neutral detergent, and then firmly wring the cloth dry before using it to wipe the surface.

Attention

- Do not use volatile substances such as wax, alcohol, or thinner to clean the projector's surface. The quality of the case may change or the paint may peel off.
- Do not touch the projection lens. When cleaning the lens, contact your local dealer or the nearest projector information center. 🖱️ [Epson Projector Contact List](#)

■ Cleaning the 3D Glasses

Clean the lenses of the glasses by wiping them gently with a soft cloth.

Attention

- Do not rub the lenses of the glasses with harsh materials or handle the lenses too roughly as they can easily become damaged.
- When maintenance is necessary, disconnect the USB Charging Adapter from the electrical outlet, and check that all cables have been disconnected.
- The 3D Glasses contain rechargeable batteries. Observe local regulations when you dispose of them.

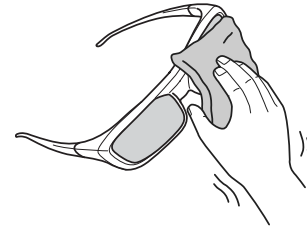



Optional Accessories and Consumables

The following optional accessories/consumables are available for purchase if required. This list of optional accessories/consumables is current as of: September 2016. Details of accessories are subject to change without notice.

Varies depending on country of purchase.

Optional Items

Name	Model No.	Explanation
RF system 3D Glasses	ELPGS03	Use when viewing 3D images.
USB Charging Adapter	ELPAC01	Use when charging the 3D Glasses.

Consumables

Name	Model No.	Explanation
Air filter	ELPAF39	Use as a replacement for used air filters. (1 air filter)



Supported Resolutions

HDMI1/HDMI2 Input Signals

Signal	Refresh Rate (Hz)	Resolution (dots)
VGA	60	640 x 480
SDTV (480i)	60	720 x 480
SDTV (576i)	50	720 x 576
SDTV (480p)	60	720 x 480
SDTV (576p)	50	720 x 576
HDTV (720p)	50/60	1280 x 720
HDTV (1080i)	50/60	1920 x 1080
HDTV (1080p)	24/30/50/60	1920 x 1080
4K x 2K	24/25/30/50/60	3840 x 2160
	50/60	4096 x 2160
4K x 2K (SMPTE)	24	4096 x 2160

Component Video

Signal	Refresh Rate (Hz)	Resolution (dots)
SDTV (480i)	60	720 x 480
SDTV (576i)	50	720 x 576
SDTV (480p)	60	720 x 480
SDTV (576p)	50	720 x 576
HDTV (720p)	50/60	1280 x 720
HDTV (1080i)	50/60	1920 x 1080
HDTV (1080p)	50/60	1920 x 1080

Composite Video

Signal	Refresh Rate (Hz)	Resolution (dots)
TV (NTSC)	60	720 x 480
TV (SECAM)	50	720 x 576
TV (PAL)	50/60	720 x 576

Computer Signals (Analog RGB)

Signal	Refresh Rate (Hz)	Resolution (dots)
VGA	60/72/75/85	640 x 480

Signal	Refresh Rate (Hz)	Resolution (dots)
SVGA	56/60/72/75/85	800 x 600
XGA	60/70/75/85	1024 x 768
SXGA	70/75/85	1152 x 864
	60/75/85	1280 x 960
	60/75/85	1280 x 1024
WXGA	60	1280 x 768
	60	1366 x 768
	60/75/85	1280 x 800
WXGA++	60	1600 x 900

3D Input Signals

Signal	Refresh Rate (Hz)	Resolution (dots)	3D Format		
			Frame Packing	Side by Side	Top and Bottom
HDTV (720p)	50/60	1280 x 720	✓	✓	✓
HDTV (1080i)	50/60	1920 x 1080	-	✓	-
HDTV (1080p)	50/60	1920 x 1080	-	✓	-
HDTV (1080p)	24	1920 x 1080	✓	✓	✓



Notes on Transportation

There are many glass parts and precision components inside the projector. To prevent damage due to impacts when transporting, handle the projector as follows.

Moving Nearby

Before carefully moving the projector, make sure it has been turned off and all cables have been disconnected.

Attention

- The projector is heavy and should not be carried by only one person. At least two people should carry the projector when unpacking or moving.
- When lifting the projector, make sure you close the control panel.
- Do not apply excessive force to the control panel section. This may cause malfunctions to occur.

When Transporting

■ Preparing packaging

After checking the points in "Moving Nearby", set the vertical and horizontal lens positions to the center, and then pack up the projector.  [p.31](#)

■ Notes when packing and transporting

Enclose the projector securely in buffer material to protect it from shock, and place it into a strong cardboard container. Be sure to notify the carrier company that the contents are fragile.

Specifications

Product name	EH-LS10500	
Appearance (not including adjustable foot)	550 (W) x 225 (H) x 553 (D) mm	
Panel size	0.74" wide	
Display method	Polysilicon TFT active matrix	
Resolution	1920 (W) x 1080 (H) x 3	
Focus adjustment	Motorized	
Zoom adjustment	Motorized (approx. 1 to 2.1)	
Light source	Laser diode, 41.9 mW, Repetition rate: 0 - 100%	
Power supply	100 - 240 V AC \pm 10%, 50/60 Hz, 4.6 - 2.1 A	
Power consumption	100 to 120 V area	Operating: 459 W
		Standby power consumption: 0.2 W*1 Standby power consumption: 2.2W*2
	220 to 240 V area	Operating: 442 W
		Standby power consumption: 0.3 W*1 Standby power consumption: 2.3 W*2
Operating altitude	Altitude 0 to 3000 m	
Operating temperature	+5 to +35°C (No condensation)	
Storage temperature	-10 to +60°C (No condensation)	
Mass	Approx. 18.0 kg	
Connectors	Component port x 1, 3RCA pin jack	
	PC port x 1, Mini D-Sub15-pin (female) blue	
	HDMI port x 2, HDMI For HDCP*3, For CEC signals, Deep Color	
	Video port x 1, RCA pin jack	
	RS-232C port x 1, D-sub 9-pin (male)	
	Trigger out port x 2, 3.5 mm mini jack	
	LAN port x1, RJ-45	
	Mini USB TypeB port x 1	

*1 When the following settings are performed

Settings - Standby Mode - Communication Off  [p.73](#)

*2 When the following settings are performed

Settings - Standby Mode - Communication On  [p.73](#)

*3 The HDMI1 port supports HDCP 2.2, and the HDMI2 port supports HDCP 1.4.

Angle of tilt

If you use the projector tilted at an angle of more than 3°, it could be damaged or cause an accident.

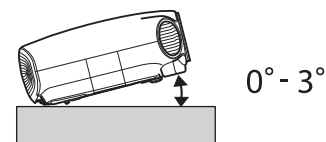

ESC/VP21 commands

Use of ESC/VP21 enables control of the projector from an external device. For more details, see the following Web site.

<http://www.epson.com>

RS-232C cable layouts

- Connector shape: D-sub 9-pin (male)
- Projector input port name: RS-232C
- Signal name:

Signal Name	Function
GND	Signal wire ground
TD	Transmit data
RD	Receive data

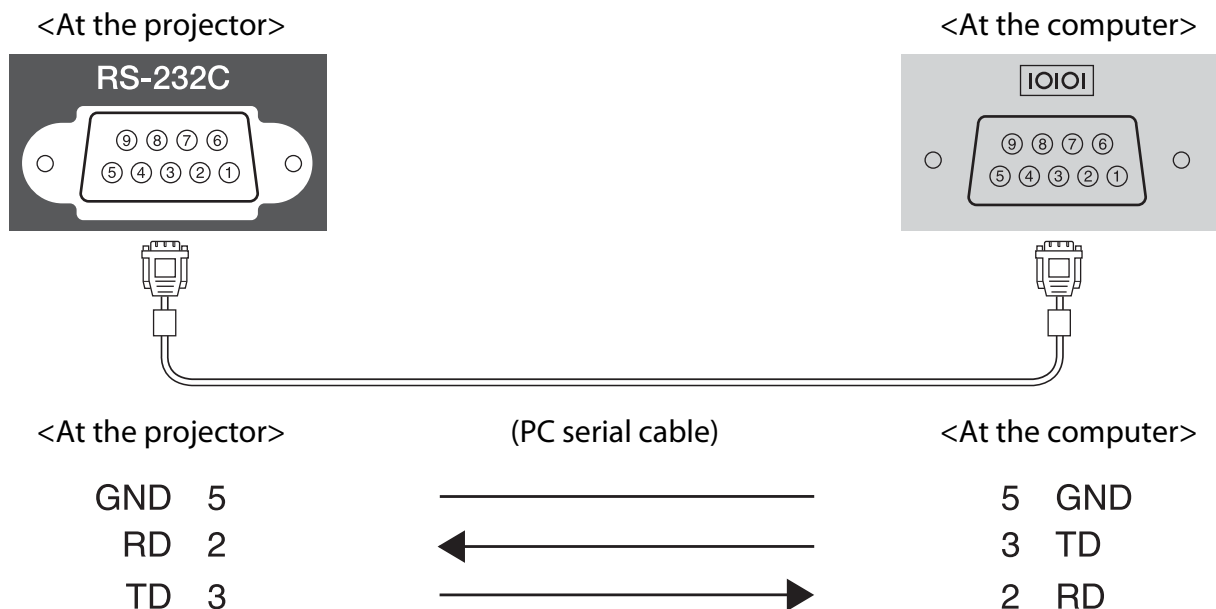

- Communications protocol
 - Default baud rate setting: 9600 bps
 - Data length: 8 bit
 - Parity: None
 - Stop-bit: 1 bit
 - Flow control: None

PJLink

The projector complies with the PJLink Class1 standard established by the JBMIA (Japan Business Machine and Information System Industries Association). From a computer connected to the projector on a network, you can control the projector with PJLink commands.

You need to make network settings before you can use PJLink. [p.77](#)

With the exception of the following commands, the projector supports all commands defined by PJLink Class1, and agreement was confirmed by the PJLink standard adaptability verification.

Function		PJLink Command
Mute settings	Image muting set	AVMT 11
	Audio muting set	AVMT 12

For more details, see the following Web site.

<http://pjlink.jbmia.or.jp/english/>

Input names defined by PJLink and corresponding projector sources

Source	PJLink Command
HDMI1	INPT 32
HDMI2	INPT 33
Component	INPT 24
Video	INPT 21
PC	INPT 11

Manufacturer name displayed for "Manufacture name information query"

EPSON

Model name displayed for "Product name information query"

EPSON 10500

DECLARATION of CONFORMITY

According to 47CFR, Part 2 and 15

Class B Personal Computers and Peripherals; and/or

CPU Boards and Power Supplies used with Class B Personal Computers

We: Epson America, Inc.
 Located at: 3840 Kilroy Airport Way
 MS: 3-13
 Long Beach, CA 90806
 Tel: 562-981-3840

Declare under sole responsibility that the product identified herein, complies with 47CFR Part 2 and 15 of the FCC rules as a Class B digital device. Each product marketed, is identical to the representative unit tested and found to be compliant with the standards. Records maintained continue to reflect the equipment being produced can be expected to be within the variation accepted, due to quantity production and testing on a statistical basis as required by 47CFR 2.909. Operation is subject to the following two conditions : (1) this device may not cause harmful interference, and (2) this device must accept any interference received, including interference that may cause undesired operation.

Trade Name: EPSON
 Type of Product: LCD Projector
 Model: H488C

FCC Compliance Statement**For United States Users**

This equipment has been tested and found to comply with the limits for a Class B digital device, pursuant to Part 15 of the FCC Rules. These limits are designed to provide reasonable protection against harmful interference in a residential installation. This equipment generates, uses, and can radiate radio frequency energy and, if not installed and used in accordance with the instructions, may cause harmful interference to radio communications. However, there is no guarantee that interference will not occur in a particular installation. If this equipment does cause harmful interference to radio or television reception, which can be determined by turning the equipment off and on, the user is encouraged to try to correct the interference by one or more of the following measures.

- Reorient or relocate the receiving antenna.
- Increase the separation between the equipment and receiver.
- Connect the equipment into an outlet on a circuit different from that to which the receiver is connected.
- Consult the dealer or an experienced radio/TV technician for help.

WARNING

The connection of a non-shielded equipment interface cable to this equipment will invalidate the FCC Certification or Declaration of this device and may cause interference levels which exceed the limits established by the FCC for this equipment. It is the responsibility of the user to obtain and use a shielded equipment interface cable with this device. If this equipment has more than one interface connector, do not leave cables connected to unused interfaces. Changes or modifications not expressly approved by the manufacturer could void the user's authority to operate the equipment.

This product is also designed for IT power distribution system with phase-to-phase voltage 230V.

Обладнання відповідає вимогам Технічного регламенту обмеження використання деяких небезпечних речовин в електричному та електронному обладнанні.



001

Indication of the manufacturer and the importer in accordance with requirements of EU directives

Manufacturer: SEIKO EPSON CORPORATION

Address: 3-5, Owa 3-chome, Suwa-shi, Nagano-ken 392-8502 Japan

Telephone: 81-266-52-3131

<http://www.epson.com/>

Importer: EPSON EUROPE B.V.

Address: Atlas Arena, Asia Building, Hoogoorddreef 5,1101 BA Amsterdam Zuidoost The Netherlands

Telephone: 31-20-314-5000

<http://www.epson.com/europe.html>



Appearance

Units: mm

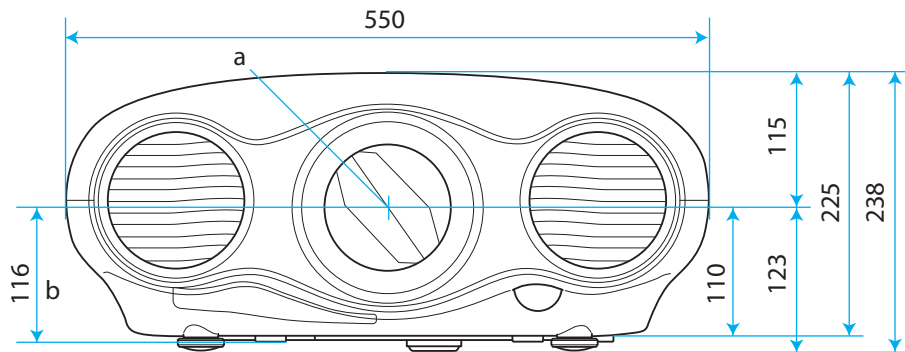

- a Center of lens
- b Distance from center of lens to suspension bracket fixing point
- c Lens direction

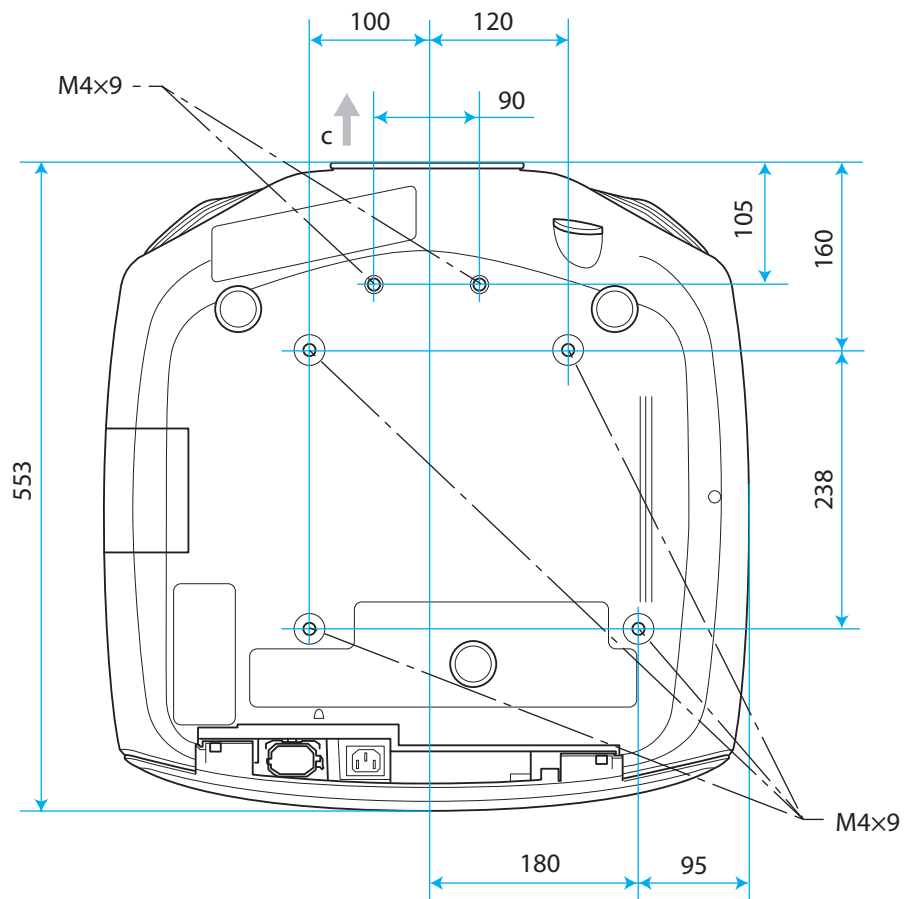



Glossary

This section briefly explains the difficult terms that are not explained in context in the text of this guide. For details, refer to other commercially available publications.

Aspect Ratio	<p>The ratio between an image's length and its height. Screens with a horizontal:vertical ratio of 16:9, such as HDTV screens, are known as wide screens.</p> <p>SDTV and general computer displays have an aspect ratio of 4:3.</p>
HDCP	<p>HDCP is an abbreviation for High-bandwidth Digital Content Protection. It is used to prevent illegal copying and protect copyrights by encrypting digital signals sent over DVI and HDMI ports. Because the HDMI port on this projector supports HDCP, it can project digital images protected by HDCP technology. However, the projector may not be able to project images protected with updated or revised versions of HDCP encryption.</p>
HDMI™	<p>An abbreviation for High Definition Multimedia Interface. This is the standard by which HD images and multichannel audio signals are digitally transmitted.</p> <p>HDMI™ is a standard aimed at digital consumer electronics and computers. By not compressing the digital signal, the image can be transferred at the highest quality possible. It also provides an encryption function for the digital signal.</p>
HDTV	<p>An abbreviation for High-Definition Television. This refers to high-definition systems which satisfy the following conditions.</p> <ul style="list-style-type: none"> • Vertical resolution of 720p or 1080i or greater (p = Progressive, i = Interlace) • Screen aspect of 16:9 Dolby Digital audio reception and playback (or output)
Interlace	<p>Transmits information needed to create one screen by sending every other line, starting from the top of the image and working down to the bottom. Images are more likely to flicker because one frame is displayed every other line.</p>
NTSC	<p>An abbreviation for the National Television Standards Committee. A terrestrial analog color broadcasting method. This method is used in Japan, North America, and Latin America.</p>
Pairing	<p>Register devices in advance when connecting with Bluetooth devices to ensure mutual communication.</p>
PAL	<p>An abbreviation for Phase Alternation by Line. A terrestrial analog color broadcasting method. This method is used in various Western European countries (with the exception of France), Asian countries such as China, and Africa.</p>
SDTV	<p>An abbreviation for Standard Definition Television. This refers to standard television systems which do not satisfy the conditions for HDTV High-Definition Television.</p>
SECAM	<p>An abbreviation for SEquential Couleur A Memoire. A terrestrial analog color broadcasting method. This method is used in France, Eastern Europe, the former Soviet Union, the Middle East, Africa, and so on.</p>
SVGA	<p>A screen size standard with a resolution of 800 (horizontal) x 600 (vertical) dots.</p>
SXGA	<p>A screen size standard with a resolution of 1,280 (horizontal) x 1,024 (vertical) dots.</p>
VGA	<p>A screen size standard with a resolution of 640 (horizontal) x 480 (vertical) dots.</p>
XGA	<p>A screen size standard with a resolution of 1,024 (horizontal) x 768 (vertical) dots.</p>
YCbCr	<p>In component image signals for SDTV, Y is the brightness, while Cb and Cr indicate the color difference.</p>
YPbPr	<p>In component image signals for HDTV, Y is the brightness, while Pb and Pr indicate the color difference.</p>



General Notes

All rights reserved. No part of this publication may be reproduced, stored in a retrieval system, or transmitted in any form or by any means, electronic, mechanical, photocopying, recording, or otherwise, without the prior written permission of Seiko Epson Corporation. No patent liability is assumed with respect to the use of the information contained herein. Neither is any liability assumed for damages resulting from the use of the information contained herein.

Neither Seiko Epson Corporation nor its affiliates shall be liable to the purchaser of this product or third parties for damages, losses, costs, or expenses incurred by the purchaser or third parties as a result of: accident, misuse, or abuse of this product or unauthorized modifications, repairs, or alterations to this product, or (excluding the U.S.) failure to strictly comply with Seiko Epson Corporation's operating and maintenance instructions.

Seiko Epson Corporation shall not be liable against any damages or problems arising from the use of any options or any consumable products other than those designated as Original Epson Products or Epson Approved Products by Seiko Epson Corporation.

The contents of this guide may be changed or updated without further notice.

Illustrations in this guide and the actual projector may differ.

Restriction of Use

When this product is used for applications requiring high reliability/safety such as transportation devices related to aviation, rail, marine, automotive etc.; disaster prevention devices; various safety devices etc; or functional/precision devices etc, you should use this product only after giving consideration to including fail-safes and redundancies into your design to maintain safety and total system reliability. Because this product was not intended for use in applications requiring extremely high reliability/safety such as aerospace equipment, main communication equipment, nuclear power control equipment, or medical equipment related to direct medical care etc, please make your own judgment on this product's suitability after a full evaluation.

Warnings and Cautions Regarding the Laser

Warning

- A laser warning label is attached to the projector.

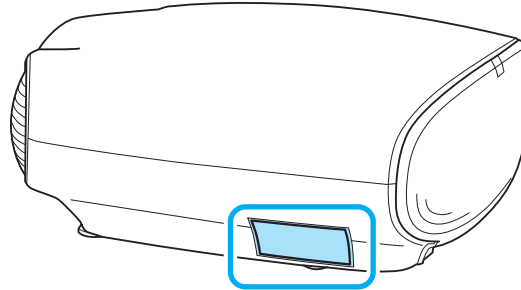

(North America, South America, Oceania)

⚠ WARNING		
	LASER RADIATION DO NOT STARE INTO BEAM CLASS 2 LASER PRODUCT	RADIACIÓN LASER NO MIRE DIRECTAMENTE A LA FUENTE DE LUZ PRODUCTO LASER CLASE 2
	LASERSTRAHLUNG NICHT IN DEN STRAHL BLICKEN LASER KLASSE 2 PRODUCT	DANGER DE RAYONNEMENT LASER NE PAS REGARDER A TRAVERS LE FAISCEAU PRODUIT LASER DE CLASSE 2
Maximum Output: 33.7mW Pulse Duration: 20µsec-CW Wavelength: 455-470nm IEC/EN60825-1:2007 Complies with FDA performance standards for laser products except for deviations pursuant to Laser Notice No. 50, dated June 24, 2007		

(Europe)

⚠ WARNING RISK GROUP 3
WARNING: Possibly hazardous optical radiation emitted from this product. AVERTISSEMENT: Rayonnement optique éventuellement dangereux émis par ce produit. ADVERTENCIA: Este producto emite una radiación óptica potencialmente peligrosa. WARNUNG: Dieses Produkt emittiert mögliche gefährliche optische Strahlung.

(Japan)

⚠ WARNING RISK GROUP 3
WARNING: Possibly hazardous optical radiation emitted from this product. 경고: 본 제품에서 위험할 수도 있는 광학적 방사선이 방출 됩니다. 警告: 此產品可能放射出危險的輻射。 警告: 該產品可能發出有害的光學輻射。 警告: 本製品からの光放射によって、眼に障害がおきる可能性があります。

(Other countries and regions)

⚠ WARNING		
	LASER RADIATION DO NOT STARE INTO BEAM CLASS 2 LASER PRODUCT	雷射輻射 請勿直視雷射光束 第2級 (CLASS 2) 雷射產品 レーザー放射 レイ저 방사 ビームをのぞき込まないこと 2 등급 레이저 제품 클래스 2 레이저 제품
	Maximum Output / 最大出力: 41.9mW Wavelength / 波長: 455-470nm	Pulse Duration / 펄스폭: 20µsec-CW IEC/EN60825-1:2007 JIS C6802:2011

(China)

⚠ 警告 激光輻射 勿直視激光束 2类激光产品 最大輸出:33.7mW 脉宽:20µs-CW 波长:455-470nm

 **Warning**

(Inside the projector (All countries/regions))

⚠ CAUTION / DANGER

CAUTION / DANGER: CLASS 4 LASER RADIATION WHEN OPEN AVOID EYE OR SKIN EXPOSURE TO DIRECT OR SCATTERED RADIATION
ATTENTION / DANGER: EN CAS D'OUVERTURE RAYONNEMENT LASER DE CLASSE 4 ÉVITER L'EXPOSITION DES YEUX OU DE LA PEAU AUX RAYONNEMENTS DIRECTS OU DIFFUSÉS
PRECAUCIÓN / PELIGRO: RADIACIÓN LÁSER DE CLASE 4 CUANDO ESTÁ ABIERTO EVITAR LA EXPOSICIÓN DE OJOS O PIEL A LA RADIACIÓN DIRECTA O DISPERSA
ACHTUNG / GEFAHR: LASERSTRAHLUNG KLASSE 4 WENN GEÖFFNET BESTRAHLUNG VON AUGEN ODER HAUT DURCH DIREKTE ODER STREUSTRALUNG VERMEIDEN
注意/危険: 打开时有4类激光辐射 避免眼或皮肤受到直射或散射辐射的照射 注意/危険: 打开时具有第4级 (CLASS 4) 雷射 避免眼睛或皮膚暴露於直射或散射的輻射
주의/위험: 개방시 4 등급 레이저 제품 직접 혹은 분사 방사에 대한 눈 또는 피부 노출을 피하십시오
注意/危険: ここを開くとクラス4のレーザー放射が出る ビームや散乱光の目又は皮膚への被ばくを避けること

⚠ CAUTION / DANGER

CAUTION / DANGER: CLASS 4 LASER RADIATION WHEN OPEN AVOID EYE OR SKIN EXPOSURE TO DIRECT OR SCATTERED RADIATION
ATTENTION / DANGER: EN CAS D'OUVERTURE RAYONNEMENT LASER DE CLASSE 4 ÉVITER L'EXPOSITION DES YEUX OU DE LA PEAU AUX RAYONNEMENTS DIRECTS OU DIFFUSÉS
PRECAUCIÓN / PELIGRO: RADIACIÓN LÁSER DE CLASE 4 CUANDO ESTÁ ABIERTO EVITAR LA EXPOSICIÓN DE OJOS O PIEL A LA RADIACIÓN DIRECTA O DISPERSA
ACHTUNG / GEFAHR: LASERSTRAHLUNG KLASSE 4 WENN GEÖFFNET BESTRAHLUNG VON AUGEN ODER HAUT DURCH DIREKTE ODER STREUSTRALUNG VERMEIDEN
注意/危険: 打开时有4类激光辐射 避免眼或皮肤受到直射或散射辐射的照射
注意/危険: 打开时具有第4级 (CLASS 4) 雷射 避免眼睛或皮膚暴露於直射或散射的輻射
주의/위험: 개방시 4 등급 레이저 제품 직접 혹은 분사 방사에 대한 눈 또는 피부 노출을 피하십시오
注意/危険: ここを開くとクラス4のレーザー放射が出る ビームや散乱光の目又は皮膚への被ばくを避けること

- Do not open the projector's case. The projector contains a high-power laser component.
- Do not look directly into the projector's light source. The powerful light emitted could cause damage to eyesight.

 **Caution**

(Europe and Japan)

This product is a class 1 laser product that conforms to IEC60825-1:2014 and JIS C 6802:2014.

(Other countries and regions)

This product is a class 2 laser product that conforms to IEC60825-1:2007 and GB7247-1:2012.

If they are not handled correctly, injuries could occur. Note the following points.

Warning

- If an error occurs in the projector, turn off the power immediately, unplug the projector from the outlet, and contact your local dealer or the nearest Epson repair center. Continuing to use it in an error condition may result in an electric shock, fire, or visual impairment.
- Never attempt to disassemble or modify the projector. The projector contains a high-power laser component. This could cause serious injury.
- Do not look into the lens during projection. This could cause visual impairment.
- When turning on the projector at a distance using the remote control, make sure there is no one looking into the lens.
- Do not allow small children to make operations. If children do make operations, they must be accompanied by an adult.
- Do not apply optical devices to the projected image. Continuing to use it in this condition may result in physical harm. It could also cause a fire or an accident.
- Before starting projection, check that there is nothing in the surrounding area that could reflect the projected image.
- When disposing of the projector, do not disassemble it. Dispose in accordance with your local or national laws and regulations.

Attention

If the high-power laser beams through the surface of the projection, it could damage the LCD display.

The emission impediment (EHVs)*1 for this device is 1.4, and the impediment distance (HD)*2 is 30 cm.

*1 The emission impediment strength (EHVs) is a value determined by the international standard IEC/TR62471-2. Indicates the degree of risk when exposed to the light source for 0.25 seconds at a distance of 20 cm. The higher the values, the higher the risk.

*2 The impediment distance (HD) is a value determined by the international standard IEC/TR62471-2. If you look into the light source at a distance closer than this, your eyesight could be damaged.

Laser optical path

When using the Lens Shift function, the laser light from the projection lens is diffused within the following range.

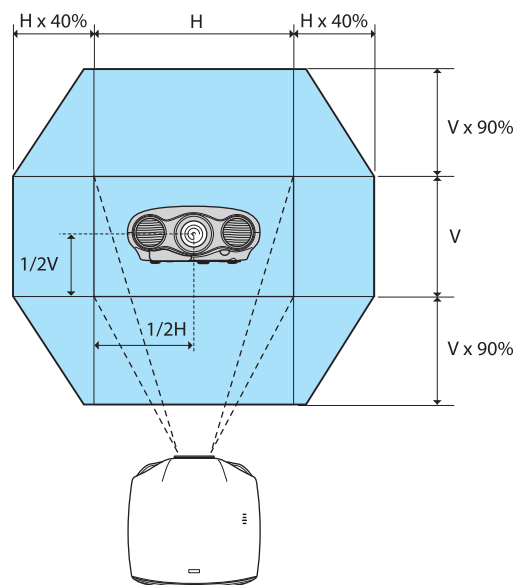















The laser beam is projected at the following angles.













When lens shift is at the maximum vertical position: 32° from the center of the lens

When lens shift is at the maximum horizontal position: 34° from the center of the lens

List of Safety Symbols

The following table lists the meaning of the safety symbols labeled on the equipment.

Symbol mark	Approved standards	Meaning
	IEC60417 No. 5007	"ON" (power) To indicate connection to the mains.
	IEC60417 No. 5008	"OFF" (power) To indicate disconnection from the mains.
	IEC60417 No. 5009	Stand-by To identify the switch or switch position by means of which part of the equipment is switched on in order to bring it into the stand-by condition.
	ISO7000 No. 0434B IEC3864-B3.1	Caution To identify general caution when using the product.
	IEC60417 No. 5041	Caution, hot surface To indicate that the marked item can be hot and should not be touched without taking care.
	IEC60417 No. 6042 ISO3864-B3.6	Caution, risk of electric shock To identify equipment that has risk of electric shock.
	IEC60417 No. 5957	For indoor use only To identify electrical equipment designed primarily for indoor use.
	IEC60417 No. 5926	Polarity of d.c. power connector To identify the positive and negative connections (the polarity) on a piece of equipment to which a d.c. power supply may be connected.
	---	
	IEC60417 No. 5001B	Battery, general On battery powered equipment. To identify a device for instance a cover for the battery compartment, or the connector terminals.
	IEC60417 No. 5002	Positioning of cell To identify the battery holder itself and to identify the positioning of the cell(s) inside the battery holder.
	---	
	IEC60417 No. 5019	Protective earth To identify any terminal which is intended for connection to an external conductor for protection against electric shock in case of a fault, or the terminal of a protective earth electrode.
	IEC60417 No. 5017	Earth To identify an earth (ground) terminal in cases where neither the symbol  is explicitly required.

Symbol mark	Approved standards	Meaning
	IEC60417 No. 5032	Alternating current To indicate on the rating plate that the equipment is suitable for alternating current only; to identify relevant terminals.
	IEC60417 No. 5031	Direct current To indicate on the rating plate that the equipment is suitable for direct current only; to identify relevant terminals.
	IEC60417 No. 5172	Class II equipment To identify equipment meeting the safety requirements specified for Class II equipment according to IEC 61140.
	ISO 3864	General prohibition To identify actions or operations that are prohibited.
	ISO 3864	Contact prohibition To indicate injury that could occur due to touching a specific part of the equipment.
	---	Never look into the projection lens while the projector is on.
	---	To indicate that the marked item don't place anything on projector.
	ISO3864 IEC60825-1	Caution, laser radiation To indicate the equipment has a laser radiation part.
	ISO 3864	Disassembly prohibition To indicate a risk of injury, such as electric shock, if the equipment is disassembled.
	---	Never look into the lens while the LED for lighting is on.
	IEC60417 No. 5266	Standby, partial standby To indicate that part of the equipment is in the ready status.
	ISO3864 IEC60417 No. 5057	Caution, movable parts To indicate that you must keep away from movable parts according to protection standards.

General Notice

"EPSON" is a registered trademark of the Seiko Epson Corporation. "EXCEED YOUR VISION" and "ELPLP" are the trademarks or registered trademarks of Seiko Epson Corporation.

HDMI and High-Definition Multimedia Interface are the trademarks or registered trademarks of HDMI Licensing LLC.  HIGH DEFINITION MULTIMEDIA INTERFACE

Adobe and Adobe RGB are registered trademarks of Adobe Systems Incorporated.

InstaPrevue and the InstaPrevue logo are the trademarks or registered trademarks of Silicon Image, Inc.

Bluetooth® and the Bluetooth logo are the trademarks of Bluetooth SIG, Inc.

Other product names used herein are also for identification purposes only and may be trademarks of their respective owners. Epson disclaims any and all rights in those marks.

©SEIKO EPSON CORPORATION 2016. All rights reserved.

- 2**
- 2D-to-3D conversion 70
- 3**
- 3D depth 70
 - 3D display 70
 - 3D format 70, 81
 - 3D Glasses 38
 - 3D images 37
 - 3D settings 70
 - 3D viewing notice 70
- A**
- Address settings 80
 - Adjust focus 30
 - Adjusting RGB 49
 - Adjusting the focus 30
 - Adjusting the tilt 29
 - Advanced 69, 71
 - Air filter 94
 - Air filter cover 94
 - AMX Device Discovery 80
 - Appearance 106
 - Aspect 32, 70
 - Auto setup 71
- B**
- Basic menu 78
 - Bonjour 80
 - Brightness 47, 68, 69
- C**
- Cable clamp 23
 - Cable cover 20
 - CEC standards 54
 - Child lock 73
 - Cleaning the 3D Glasses 96
 - Cleaning the air filter 94
 - Cleaning the main unit 95
 - Color Depth 81
 - Color Format 81
 - Color mode 42, 68
 - Color saturation 68
 - Color Space 72
 - Color temp. 68
 - Complete menu 80
 - Component 76
 - Component ports 20
 - Configuration menu 27, 68
 - Connecting 20
 - Connecting a computer 21
 - Connecting video devices 20
 - Contrast 68
 - Control panel 6, 10
 - Control panel lock 73
- D**
- Deinterlacing 70
 - Detail enhancement 45, 71
 - Device connections 73
 - DHCP 79
 - Diagonal screen size 70
 - Direct power on 75
 - Display background 76
 - Display settings 76
 - Displaying the test pattern 29
 - Dynamic contrast 45
 - Dynamic Range 72
- E**
- EDID 72
 - EPSON Super White 69
 - Erase lens position 57, 77
 - Erase memory 59, 77
 - Error/warning indicators 83
 - Exit Picture in Picture 82
- F**
- Focus 88
 - Frame interpolation 46, 71
 - Full 32
- G**
- Gain 49, 69
 - Gamma 47, 69
 - Gateway address 79
- H**
- HDMI link 54, 73
 - HDMI port 54
 - HDMI video range 72
 - HDMI1 port 20, 21
 - HDMI2 port 20, 21
 - High altitude mode 75
 - Hue 47, 69
- I**
- Illumination 75
 - Image 42
 - Image menu 68
 - Image processing 72
 - Indicators 83

- Info menu 81
 - Input signal 76, 81
 - Inverse 3D Glasses 70
 - IP address 79
 - IP address display 79
 - IP settings 79
- K**
- Keystone 31, 73
 - Keystone distortion 31
- L**
- LAN port 23
 - Language 76
 - Lens iris 51, 69
 - Lens position function 56
 - Lens shift 31
 - Load lens position 56, 77
 - Load memory 59, 77
 - Lock setting 73
- M**
- Mail menu 79
 - Mail notification 66, 79
 - Memory function 58
 - Memory menu 77
 - Menu 68
 - Menu color 76
 - Menu position 76
 - Messages 76
 - Model name 76
 - Motion detection 70
- N**
- Network information 78
 - Network menu 77
 - Noise 88
 - Noise reduction 71
- O**
- Offset 49, 69
 - Operating range 24
 - Operation 75
 - Others menu 80
 - Overscan 72
- P**
- Pairing 39
 - Panel alignment 76
 - Pattern color 76
 - PC port 21
 - Picture in Picture 61, 82
 - PJLink 102
 - PJLink password 78
 - Port number 79
 - Position 70
 - Power consumption 69
 - Power off link 73
 - Power on link 73
 - Power supply 25, 26
 - Projection 74
 - Projection distance 17
 - Projection size 17, 30
 - Projector name 78
- R**
- Refresh rate 81
 - Remote control 11, 24
 - Rename lens position 57, 77
 - Rename memory 59, 77
 - Replacing the air filter 94
 - Reset 69, 72, 76, 77
 - Reset all 82
 - Reset lens position 57, 82
 - Reset memory 59, 82
 - Reset menu 80, 82
 - Resolution 81
 - RGB 69
 - RGBCMY 47, 69
- S**
- Saturation 47, 69
 - Save lens position 56, 77
 - Save memory 58, 77
 - Scan mode 81
 - Select color 76
 - Serial number 81
 - Settings menu 73
 - Setup complete menu 78
 - Setup level 71
 - Sharpness 50, 68
 - Signal menu 70
 - Skin tone 68
 - Sleep mode 75
 - SMTP server 79
 - Soft keyboard 80
 - Source 32, 81
 - Specifications 101
 - Standby confirmation 76
 - Start adjustments 76
 - Startup screen 76
 - Status 81
 - Sub menu 27

Subnet mask	79
Subscreen position	82
Subscreen size	82
Super-resolution/4K	43, 71
Supported resolutions	98
Swap main/sub	82
Sync info	81
Sync.	70
T	
Tint	68
Top menu	27
Tracking	70
Trigger out 1	75
Trigger out 2	75
U	
User button	74
V	
Version	81
Video port	20
Video signal	76, 81
Viewing area	39
W	
Web browser	63
Web Control	63
Web Control password	78
Web Remote	64
Wired LAN menu	79
Z	
Zoom	32
Zoom adjustment	30